

TOP-DESIGN

2024



EDYCJA I - katalog obowiązuje od 1.05.2024 do 31.12.2024 lub do wyczerpania zapasów.

PALAZZANI

Roth

AZZURRA

omegius

**CERAMICA
ALTHEA**

dD



POWŁOKA
OCHRONNA
SZKŁA



MI D2L / MI D2R

- » powolne, automatyczne zamykanie i otwieranie dzięki systemom **SOFTCLOSE / SOFTOPEN**
- » wysokość 2050 mm razem z elementami nośnymi
- » 6 mm ESG szkło bezpieczne
- » GWARANCJA 5 LAT



6 mm ESG
szkło bezpieczne
transparent



Profil
BRILLANT
/ BLACK

Jednoskrzydłowe przesuwne drzwi prysznicowe do wnęki

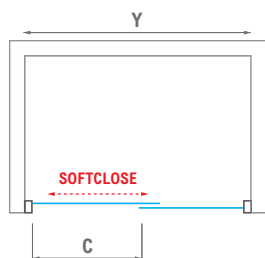

MI D2R
wersja
prawa

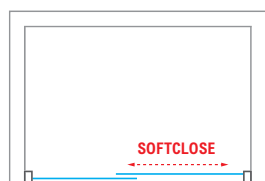

MI D2L
wersja
lewa



MODEL	NUMER KATALOGOWY	WYMIAR (mm)	SZEROKOŚĆ (Y)	PROFIL	WEJŚCIE (C)	CENA NETTO
MID2L/1000	MI D2L 100205 VPE	1000	970-1010	brillant	400	3069,-
MID2L/1000	MI D2L 100205 NPE	1000	970-1010	black	400	3069,-
MI D2L/1100	MI D2L 110205 VPE	1100	1070-1110	brillant	450	3143,-
MI D2L/1100	MI D2L 110205 NPE	1100	1070-1110	black	450	3143,-
MI D2L/1200	MI D2L 120205 VPE	1200	1170-1210	brillant	500	3217,-
MI D2L/1200	MI D2L 120205 NPE	1200	1170-1210	black	500	3217,-
MI D2L/1300	MI D2L 130205 VPE	1300	1270-1310	brillant	550	3288,-
MI D2L/1300	MI D2L 130205 NPE	1300	1270-1310	black	550	3288,-
MI D2L/1400	MI D2L 140205 VPE	1400	1370-1410	brillant	600	3362,-
MI D2L/1400	MI D2L 140205 NPE	1400	1370-1410	black	600	3362,-
MID2L/1500	MI D2L 150205 VPE	1500	1470-1510	brillant	650	3436,-
MID2L/1500	MI D2L 150205 NPE	1500	1470-1510	black	650	3436,-
MID2L/1600	MI D2L 160205 VPE	1600	1570-1610	brillant	700	3510,-
MID2L/1600	MI D2L 160205 NPE	1600	1570-1610	black	700	3510,-
MI D2L/1700	MI D2L 170205 VPE	1700	1670-1710	brillant	750	3585,-
MI D2L/1700	MI D2L 170205 NPE	1700	1670-1710	black	750	3585,-
MI D2L/1800	MI D2L 180205 VPE	1800	1770-1810	brillant	800	3648,-
MI D2L/1800	MI D2L 180205 NPE	1800	1770-1810	black	800	3648,-
MI D2R/1000	MI D2R 100205 VPE	1000	970-1010	brillant	400	3069,-
MI D2R/1000	MI D2R 100205 NPE	1000	970-1010	black	400	3069,-
MI D2R/1100	MI D2R 110205 VPE	1100	1070-1110	brillant	450	3143,-
MI D2R/1100	MI D2R 110205 NPE	1100	1070-1110	black	450	3143,-
MI D2R/1200	MI D2R 120205 VPE	1200	1170-1210	brillant	500	3217,-
MI D2R/1200	MI D2R 120205 NPE	1200	1170-1210	black	500	3217,-
MI D2R/1300	MI D2R 130205 VPE	1300	1270-1310	brillant	550	3288,-
MI D2R/1300	MI D2R 130205 NPE	1300	1270-1310	black	550	3288,-
MI D2R/1400	MI D2R 140205 VPE	1400	1370-1410	brillant	600	3362,-
MI D2R/1400	MI D2R 140205 NPE	1400	1370-1410	black	600	3362,-
MI D2R/1500	MI D2R 150205 VPE	1500	1470-1510	brillant	650	3436,-
MI D2R/1500	MI D2R 150205 NPE	1500	1470-1510	black	650	3436,-
MI D2R/1600	MI D2R 160205 VPE	1600	1570-1610	brillant	700	3510,-
MI D2R/1600	MI D2R 160205 NPE	1600	1570-1610	black	700	3510,-
MI D2R/1700	MI D2R 170205 VPE	1700	1670-1710	brillant	750	3585,-
MI D2R/1700	MI D2R 170205 NPE	1700	1670-1710	black	750	3585,-
MI D2R/1800	MI D2R 180205 VPE	1800	1770-1810	brillant	800	3648,-
MI D2R/1800	MI D2R 180205 NPE	1800	1770-1810	black	800	3648,-



POWŁOKA
OCHRONNA
SZKŁA



MI D2L/R + MI FX2

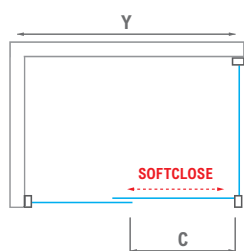

**MI D2L
+ MI FX2**
wersja
lewa

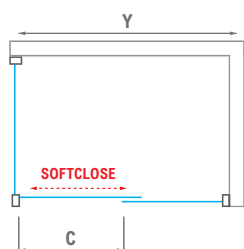

**MI D2R
+ MI FX2**
wersja
prawa

- » powolne, automatyczne zamykanie i otwieranie dzięki systemom **SOFTCLOSE / SOFTOPEN**
- » wysokość 2050 mm razem z elementami nośnymi
- » 6 mm ESG szkło bezpieczne
- » GWARANCJA 5 LAT



6 mm ESG
szkło bezpieczne
transparent



Profil
BRILLANT
/ **BLACK**

Jednoskrzydłowe przesuwne drzwi przysznicowe

MODEL	NUMER KATALOGOWY	WYMIAR (mm)	SZEROKOŚĆ (Y)	PROFIL	WEJŚCIE (C)	CENA NETTO
MID2L/1000	MI D2L 100205 VPE	1000	970-1010	brillant	400	3069,-
MID2L/1000	MI D2L 100205 NPE	1000	970-1010	black	400	3069,-
MI D2L/1100	MI D2L 110205 VPE	1100	1070-1110	brillant	450	3143,-
MI D2L/1100	MI D2L 110205 NPE	1100	1070-1110	black	450	3143,-
MI D2L/1200	MI D2L 120205 VPE	1200	1170-1210	brillant	500	3217,-
MI D2L/1200	MI D2L 120205 NPE	1200	1170-1210	black	500	3217,-
MI D2L/1300	MI D2L 130205 VPE	1300	1270-1310	brillant	550	3288,-
MI D2L/1300	MI D2L 130205 NPE	1300	1270-1310	black	550	3288,-
MI D2L/1400	MI D2L 140205 VPE	1400	1370-1410	brillant	600	3362,-
MI D2L/1400	MI D2L 140205 NPE	1400	1370-1410	black	600	3362,-
MID2L/1500	MI D2L 150205 VPE	1500	1470-1510	brillant	650	3436,-
MID2L/1500	MI D2L 150205 NPE	1500	1470-1510	black	650	3436,-
MID2L/1600	MI D2L 160205 VPE	1600	1570-1610	brillant	700	3510,-
MID2L/1600	MI D2L 160205 NPE	1600	1570-1610	black	700	3510,-
MI D2L/1700	MI D2L 170205 VPE	1700	1670-1710	brillant	750	3585,-
MI D2L/1700	MI D2L 170205 NPE	1700	1670-1710	black	750	3585,-
MI D2L/1800	MI D2L 180205 VPE	1800	1770-1810	brillant	800	3648,-
MI D2L/1800	MI D2L 180205 NPE	1800	1770-1810	black	800	3648,-
MI D2R/1000	MI D2R 100205 VPE	1000	970-1010	brillant	400	3069,-
MI D2R/1000	MI D2R 100205 NPE	1000	970-1010	black	400	3069,-
MI D2R/1100	MI D2R 110205 VPE	1100	1070-1110	brillant	450	3143,-
MI D2R/1100	MI D2R 110205 NPE	1100	1070-1110	black	450	3143,-
MI D2R/1200	MI D2R 120205 VPE	1200	1170-1210	brillant	500	3217,-
MI D2R/1200	MI D2R 120205 NPE	1200	1170-1210	black	500	3217,-
MI D2R/1300	MI D2R 130205 VPE	1300	1270-1310	brillant	550	3288,-
MI D2R/1300	MI D2R 130205 NPE	1300	1270-1310	black	550	3288,-
MI D2R/1400	MI D2R 140205 VPE	1400	1370-1410	brillant	600	3362,-
MI D2R/1400	MI D2R 140205 NPE	1400	1370-1410	black	600	3362,-
MI D2R/1500	MI D2R 150205 VPE	1500	1470-1510	brillant	650	3436,-
MI D2R/1500	MI D2R 150205 NPE	1500	1470-1510	black	650	3436,-
MI D2R/1600	MI D2R 160205 VPE	1600	1570-1610	brillant	700	3510,-
MI D2R/1600	MI D2R 160205 NPE	1600	1570-1610	black	700	3510,-
MI D2R/1700	MI D2R 170205 VPE	1700	1670-1710	brillant	750	3585,-
MI D2R/1700	MI D2R 170205 NPE	1700	1670-1710	black	750	3585,-
MI D2R/1800	MI D2R 180205 VPE	1800	1770-1810	brillant	800	3648,-
MI D2R/1800	MI D2R 180205 NPE	1800	1770-1810	black	800	3648,-

Ścianka boczna MELI

MODEL	NUMER KATALOGOWY	WYMIAR (mm)	SZEROKOŚĆ (X)	PROFIL	WEJŚCIE (C)	CENA NETTO
MI FX2/750	MI FX2 075205 VPE	750	725-750	brillant	---	1198,-
MI FX2/750	MI FX2 075205 NPE	750	725-750	black	---	1198,-
MI FX2/800	MI FX2 080205 VPE	800	775-800	brillant	---	1224,-
MI FX2/800	MI FX2 080205 NPE	800	775-800	black	---	1224,-
MI FX2/900	MI FX2 090205 VPE	900	875-900	brillant	---	1279,-
MI FX2/900	MI FX2 090205 NPE	900	875-900	black	---	1279,-
MI FX2/1000	MI FX2 100205 VPE	1000	975-1000	brillant	---	1341,-
MI FX2/1000	MI FX2 100205 NPE	1000	975-1000	black	---	1341,-
MI FX2/1100	MI FX2 110205 VPE	1100	1075-1100	brillant	---	1393,-
MI FX2/1100	MI FX2 110205 NPE	1100	1075-1110	black	---	1393,-
MI FX2/1200	MI FX2 120205 VPE	1200	1175-1200	brillant	---	1448,-
MI FX2/1200	MI FX2 120205 NPE	1200	1175-1200	black	---	1448,-



BELITA
B E L I T A



Profil
BRILLANT

POWŁOKA
OCHRONNA
SZKŁA



8 mm ESG
szkło bezpieczne
transparent

BI PF2+BI SET

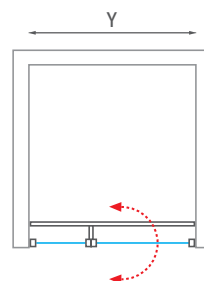

- » wysokość: 2020 mm razem z elementami nośnymi
- » drzwi: otwierane do wewnątrz i na zewnątrz
- » uniwersalna wersja lewa i prawa
- » Y – wymiar montażowy na brodzik
- » 8 mm ESG szkło bezpieczne
- » GWARANCJA 5 LAT



Profil
BLACK



Jednoskrzydłowe drzwi prysznicowe BI PF2

MODEL	NR KATALOGOWY	ROZMIAR (Y)	WEJŚCIE (C)	PROFIL	CENA NETTO
BI PF2/800	BI PF2/08020 NPE	782-807	487	black	1457,-
BI PF2/800	BI PF2/08020 VPE	782-807	487	brillant	1412,-
BI PF2/900	BI PF2/09020 NPE	882-907	587	black	1559,-
BI PF2/900	BI PF2/09020 VPE	882-907	587	brillant	1505,-
BI PF2/1000	BI PF2/10020 NPE	982-1007	587	black	1664,-
BI PF2/1000	BI PF2/10020 VPE	982-1007	587	brillant	1595,-
BI PF2/1200	BI PF2/12020 NPE	1182-1207	637	black	1836,-
BI PF2/1200	BI PF2/12020 VPE	1182-1207	637	brillant	1779,-

INSTALACJA DO WNĘKI	WYMIARY INSTALACJI (Y)
BI PF2/800 + BI SET	775-810
BI PF2/900 + BI SET	875-910
BI PF2/1000 + BI SET	975-1010
BI PF2/1200 + BI SET	1175-1210

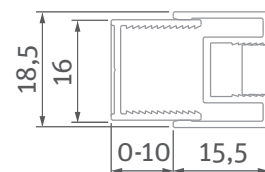

BI SET – zestaw profili

Zestaw montażowy do wnęki

MODEL	NR KATALOGOWY	ROZMIAR (Y)	PROFIL	CENA NETTO
BI SET	BI SET 2000 NE	15-20	black	184,-
BI SET	BI SET 2000 VE	15-20	brillant	179,-



BELITA
BELITA

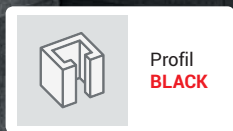

Profil
BLACK

POWŁOKA
OCHRONNA
SZKŁA

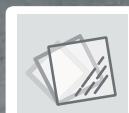

8 mm ESG
szkło bezpieczne
transparent

BI PF2+BI FXP



Profil
BRILLANT



- » wysokość: 2020 mm razem z elementami nośnymi
- » drzwi: otwierane do wewnątrz i na zewnątrz
- » uniwersalna wersja lewa i prawa
- » 8 mm ESG szkło bezpieczne
- » GWARANCJA 5 LAT



Jednoskrzydłowe drzwi prysznicowe BI PF2

MODEL	NR KATALOGOWY	ROZMIAR (Y)	WEJŚCIE (C)	PROFIL	CENA NETTO
BI PF2/800	BI PF2/08020 NPE	782-807	487	black	1457,-
BI PF2/800	BI PF2/08020 VPE	782-807	487	brillant	1412,-
BI PF2/900	BI PF2/09020 NPE	882-907	587	black	1559,-
BI PF2/900	BI PF2/09020 VPE	882-907	587	brillant	1505,-
BI PF2/1000	BI PF2/10020 NPE	982-1007	587	black	1664,-
BI PF2/1000	BI PF2/10020 VPE	982-1007	587	brillant	1595,-
BI PF2/1200	BI PF2/12020 NPE	1182-1207	637	black	1836,-
BI PF2/1200	BI PF2/12020 VPE	1182-1207	637	brillant	1779,-



Ścianka boczna BI FXP

MODEL	NR KATALOGOWY	ROZMIAR (Y)	PROFIL	CENA NETTO
BI FXP/800	BI FXP/08020 NPE	772-797	black	945,-
BI FXP/800	BI FXP/08020 VPE	772-797	brillant	924,-
BI FXP/900	BI FXP/09020 NPE	872-897	black	1048,-
BI FXP/900	BI FXP/09020 VPE	872-897	brillant	1026,-
BI FXP/1000	BI FXP/10020 NPE	972-997	black	1150,-
BI FXP/1000	BI FXP/10020 VPE	972-997	brillant	1126,-

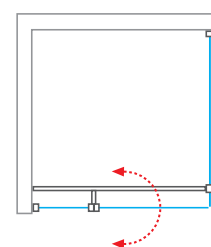

OB LINE

OB LINE BLACK
OB LINE BLACK



POWŁOKA
OCHRONNA
SZKŁA

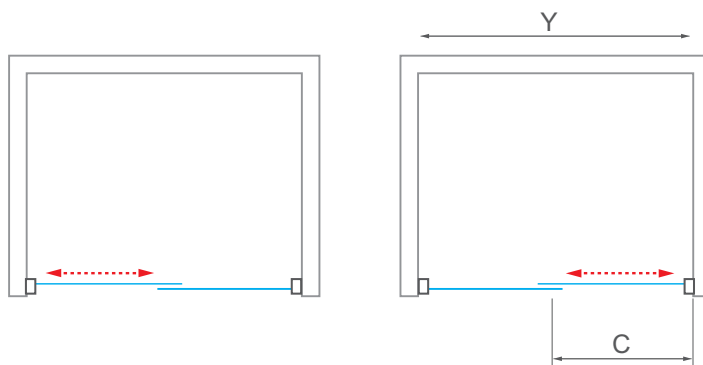

OBZD2

- » uniwersalna wersja lewa i prawa
- » 8 mm ESG szkło bezpieczne
- » rodzaj szkła: transparent
- » wysokość 1950 mm
- » Y – wymiar montażowy na brodzik
- » GWARANCJA 3 LATA

**Profil
BLACK**

**8 mm ESG
szkło bezpieczne
transparent**
**Jednoskrzydłowe
przesuwne drzwi prysznicowe
do wnęki lub do ścianki bocznej**

MODEL	NR KATALOGOWY	ROZMIAR (Y)	WEJŚCIE (C)	CENA NETTO
OBZD2/1200_BLACK	4000800	1180-1220	490	1799,-
OBZD2/1400_BLACK	4000801	1380-1420	590	1899,-

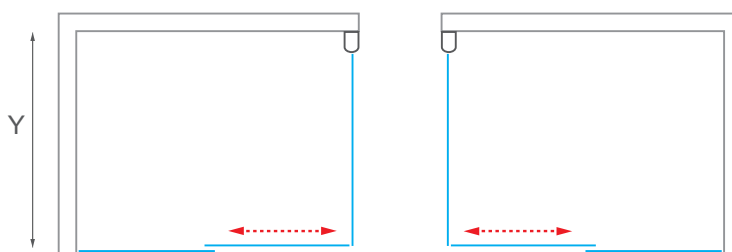
OBZD2+OBZB

- » uniwersalna wersja lewa i prawa
- » 8 mm ESG szkło bezpieczne
- » rodzaj szkła: transparent
- » wysokość 1950 mm
- » Y – wymiar montażowy na brodzik
- » GWARANCJA 3 LATA

**Profil
BLACK**

**8 mm ESG
szkło bezpieczne
transparent**
Ścianka boczna

MODEL	NR KATALOGOWY	ROZMIAR (Y)	CENA NETTO
OBZB/800_BLACK	4000802	780-800	879,-
OBZB/900_BLACK	4000803	880-900	999,-



POWŁOKA
OCHRONNA
SZKŁA



OBZD2

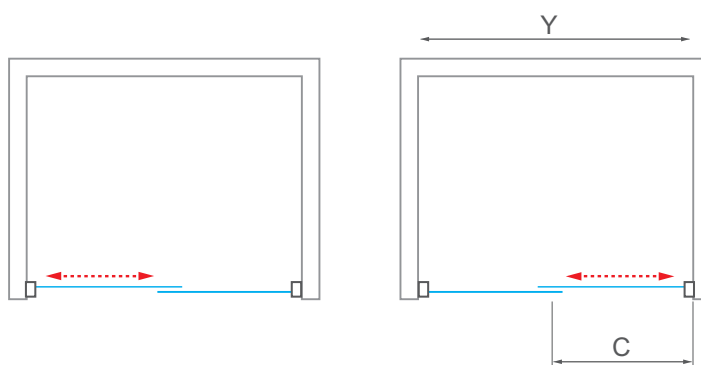

- » uniwersalna wersja lewa i prawa
- » 8 mm ESG szkło bezpieczne
- » rodzaj szkła: transparent
- » wysokość 1950 mm
- » Y - wymiar montażowy na brodzik
- » GWARANCJA 3 LATA



Profil
BRILLANT



8 mm ESG
szkło bezpieczne
transparent

Jednoskrzydłowe
przesuwne drzwi prysznicowe
do wnęki lub do ścianki bocznej

MODEL	NR KATALOGOWY	ROZMIAR (Y)	WEJŚCIE (C)	CENA NETTO
OBZD2/1200	4000713	1180-1220	490	1799,-
OBZD2/1400	4000714	1380-1420	590	1899,-

OBZD2+OBZB

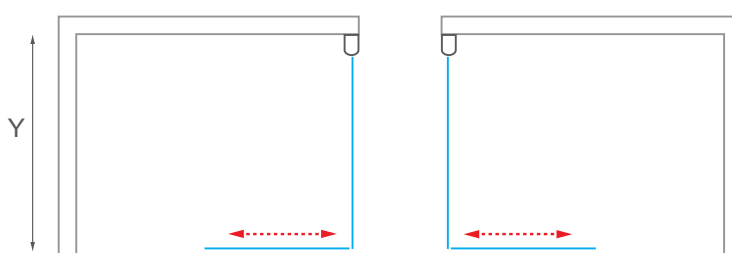

- » uniwersalna wersja lewa i prawa
- » 8 mm ESG szkło bezpieczne
- » rodzaj szkła: transparent
- » wysokość 1950 mm
- » Y - wymiar montażowy na brodzik
- » GWARANCJA 3 LATA



Profil
BRILLANT



8 mm ESG
szkło bezpieczne
transparent

Ścianka boczna

MODEL	NR KATALOGOWY	ROZMIAR (Y)	CENA NETTO
OBZB/800	4000715	780-800	879,-
OBZB/900	4000716	880-900	999,-

WALK IN ALINA



POWŁOKA
OCHRONNA
SZKŁA



WALK IN ALINA

WALK IN ALINA

AI TWF

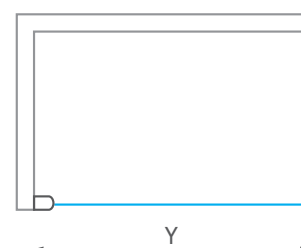

- » uniwersalna wersja lewa i prawa
- » **10 mm ESG szkło bezpieczne**
- » rodzaj szkła: transparent
- » wysokość 2002 mm łącznie z elementami nośnymi
- » Y – wymiar montażowy na brodzik
- » **GWARANCJA 2 LATA**

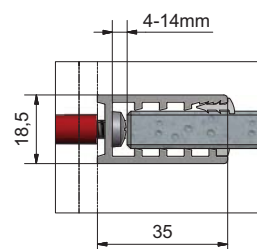

Ścianka Walk In Alina



Profil
BLACK



Profil
BRILLANT

MODEL	NR KATALOGOWY	WYMIAR (mm)	SZEROKOŚĆ (Y)	PROFIL	CENA NETTO
AI TWF/400	AI TWF 040200 VPE	400	380-390	brillant	959,-
AI TWF/400	AI TWF 040200 NPE	400	380-390	black	959,-
AI TWF/500	AI TWF 050200 VPE	500	480-490	brillant	1102,-
AI TWF/500	AI TWF 050200 NPE	500	480-490	black	1102,-
AI TWF/600	AI TWF 060200 VPE	600	580-590	brillant	1246,-
AI TWF/600	AI TWF 060200 NPE	600	580-590	black	1246,-
AI TWF/700	AI TWF 070200 VPE	700	680-690	brillant	1400,-
AI TWF/700	AI TWF 070200 NPE	700	680-690	black	1400,-
AI TWF/800	AI TWF 080200 VPE	800	780-790	brillant	1562,-
AI TWF/800	AI TWF 080200 NPE	800	780-790	black	1562,-
AI TWF/900	AI TWF 090200 VPE	900	880-890	brillant	1776,-
AI TWF/900	AI TWF 090200 NPE	900	880-890	black	1776,-
AI TWF/1000	AI TWF 100200 VPE	1000	980-990	brillant	1926,-
AI TWF/1000	AI TWF 100200 NPE	1000	980-990	black	1926,-
AI TWF/1100	AI TWF 110200 VPE	1100	1080-1090	brillant	2069,-
AI TWF/1100	AI TWF 110200 NPE	1100	1080-1090	black	2069,-
AI TWF/1200	AI TWF 120200 VPE	1200	1180-1190	brillant	2212,-
AI TWF/1200	AI TWF 120200 NPE	1200	1180-1190	black	2212,-
AI TWF/1400	AI TWF 140200 VPE	1400	1380-1390	brillant	2498,-
AI TWF/1400	AI TWF 140200 NPE	1400	1380-1390	black	2498,-

CALIDA WALK IN



Profil
BRILLANT

CI TWF



Profil
BLACK



6 mm ESG
szkło bezpieczne
transparent 02
z folią ochronną



POWŁOKA
OCHRONNA
SZKŁA



- » wysokość 2020 mm razem z elementami nośnymi
- » uniwersalna wersja lewa i prawa
- » 6 mm ESG szkło bezpieczne
- » FOLIA OCHRONNA: transparent
- » GWARANCJA 5 LAT

Ścianka CALIDA Walk In Black

MODEL	NR KATALOGOWY	SZEROKOŚĆ (Y)	CENA NETTO
CI TWF / 800	CI TWF 08020 NPF	773-800	1153,-
CI TWF / 900	CI TWF 09020 NPF	873-900	1225,-
CI TWF / 1000	CI TWF 10020 NPF	973-1000	1317,-
CI TWF / 1100	CI TWF 11020 NPF	1073-1100	1410,-
CI TWF / 1200	CI TWF 12020 NPF	1173-1200	1504,-
CI TWF / 1400	CI TWF 14020 NPF	1373-1400	1688,-

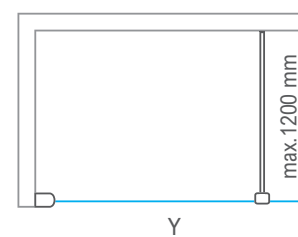
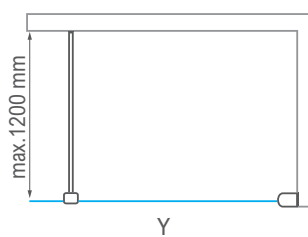



POWŁOKA
OCHRONNA
SZKŁA



CI BAF

- » grubość szkła 6 mm
- » uniwersalna wersja lewa i prawa
- » wysokość łącznie z elementami nośnymi



Profil
BLACK

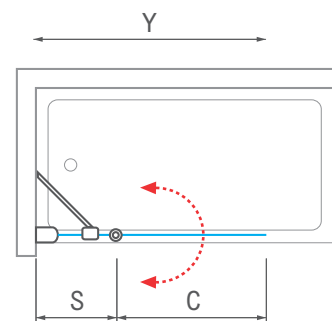

6 mm ESG
szkło bezpieczne
transparent

Parawan nawannowy otwierany dwustronnie ze ścianką stałą

MODEL	NUMER KATALOGOWY	SZEROKOŚĆ (Y)	WYSOKOŚĆ (H)	SZEROKOŚĆ WEJŚCIA (C)	SZEROKOŚĆ BOKU (S)	PROFIL	CENA NETTO
CI BAF/1100	CI BAF 110150 NPE	1090-1115	1523 mm	570	420-445	black	1549,-



Profil
BLACK



CI BAE

- » grubość szkła 6 mm
- » uniwersalna wersja lewa i prawa
- » wysokość łącznie z elementami nośnymi

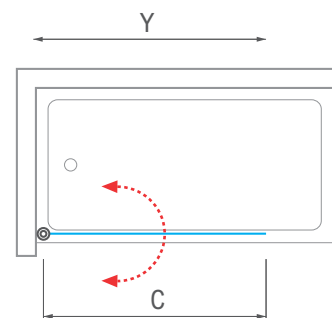

6 mm ESG
szkło bezpieczne
transparent

Parawan nawannowy otwierany

MODEL	NUMER KATALOGOWY	SZEROKOŚĆ (Y)	WYSOKOŚĆ (H)	SZEROKOŚĆ WEJŚCIA (C)	PROFIL	CENA NETTO
CI BAE/750	CI BAE 075150 NPE	740-765	1502 mm	665	black	1149,-

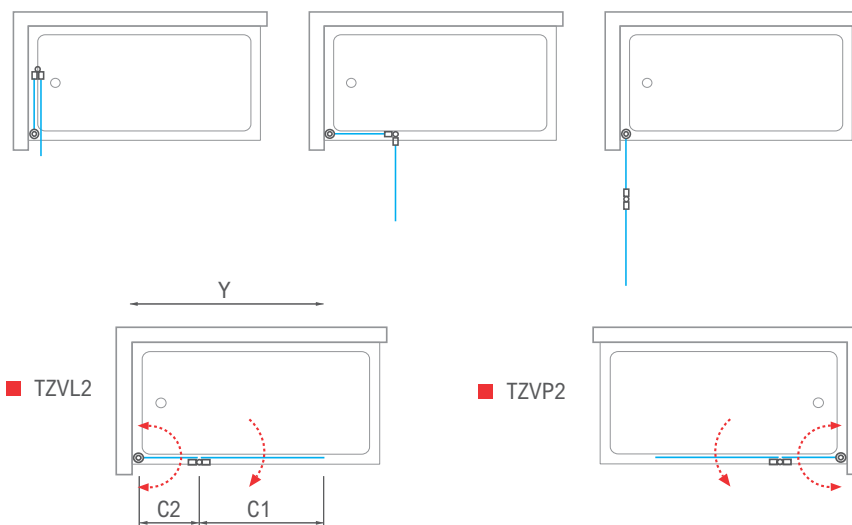

TZVL2

 POWŁOKA
OCHRONNA
SZKŁA

Parawan nawannowy otwierany dwustronnie

MODEL	NUMER KATALOGOWY	SZEROKOŚĆ (Y)	WYSOKOŚĆ (H)	SZEROKOŚĆ WEJŚCIA (C)	CENA NETTO
TZVL2/1000	742-100000L-00-02	990-1005	1420	c1=420 c2=520	2249,-
TZVP2/1000	742-100000P-00-02	990-1005	1420	c1=420 c2=520	2249,-

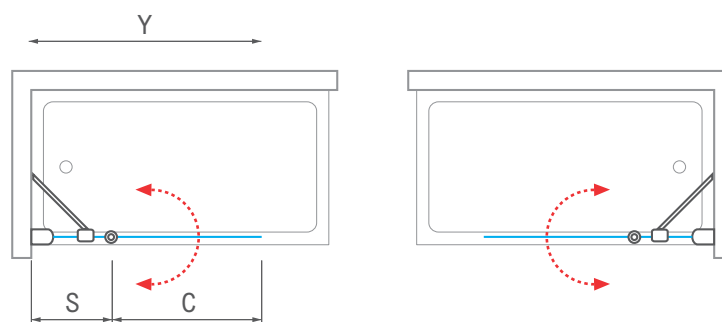
6 mm ESG
szkło bezpieczne
transparent 02

TV2

- » uniwersalna wersja lewa i prawa
- » grubość szkła 6 mm

 POWŁOKA
OCHRONNA
SZKŁA

Parawan nawannowy otwierany dwustronnie ze ścianką stałą

MODEL	NUMER KATALOGOWY	SZEROKOŚĆ (Y)	WYSOKOŚĆ (H)	SZEROKOŚĆ WEJŚCIA (C)	CENA NETTO
TV2	732-9700000-00-02	970	1420	c1=430 c2=540	1549,-

6 mm ESG
szkło bezpieczne
transparent 02



KUBIC NEO SLIM



Prostokątna wanna akrylowa z niskim rantem

MODEL	NUMER KATALOGOWY	WYMIARY (mm)	POJEMNOŚĆ (l)	CENA NETTO
KUBIC NEO SLIM 150×70	9300SLM	1500×700	200	1720,-
KUBIC NEO SLIM 160×70	9310SLM	1600×700	210	1756,-
KUBIC NEO SLIM 170×75	9330SLM	1700×750	230	1902,-
KUBIC NEO SLIM 180×80	9340SLM	1800×800	250	2252,-



MODEL	L	W	H	G	D	R	P	S	E	F	Z
1500x700	1500	700	435	340	970	18	560	400	1360	560	290
1600x700	1600	700	435	340	1070	18	560	400	1460	560	290
1700x750	1700	750	435	340	1170	18	560	420	1560	610	290
1800x800	1800	800	455	360	1270	18	560	450	1660	660	290

Nogi do wanien

NUMER KATALOGOWY	CENA NETTO
5139300	99,-

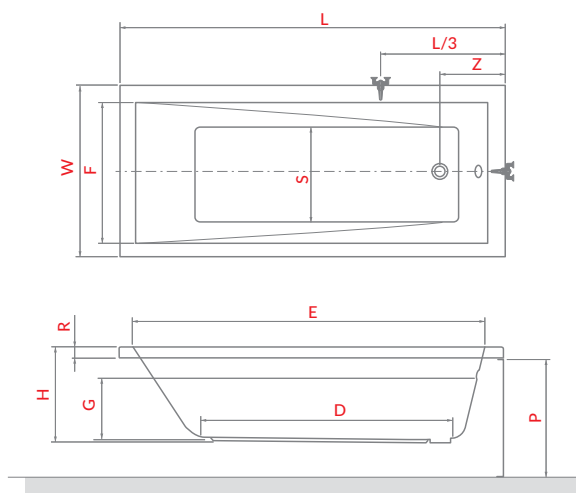

SAVONA NEO



Prostokątna wanna akrylowa

MODEL	NR KATALOGOWY	WYMIARY (mm)	POJEMNOŚĆ (l)	CENA NETTO
SAVONA 170	9290000	1700 x 800	190	1794,-
SAVONA 180	9280000	1800 x 800	200	1852,-



MODEL	L	W	H	G	D	R	S	F1	F2	Z
1700x800	1700	800	440	350	1140	40	580	60	90	265
1800x800	1800	800	440	350	1240	40	580	60	90	265

Nogi do wanien

NUMER KATALOGOWY	CENA NETTO
5139300	99,-

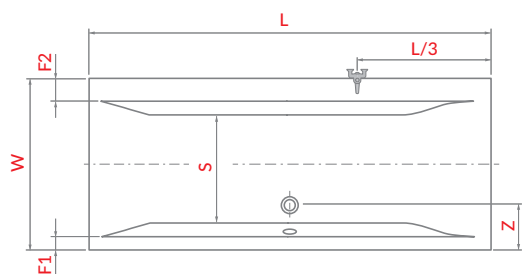

CLASSIC PRO



Prostokątna wanna akrylowa

MODEL	NR KATALOGOWY	WYMIARY (mm)	POJEMNOŚĆ (l)	CENA NETTO
CLASSIC PRO 150	9040000	1500 x 700	150	1089,-
CLASSIC PRO 160	9050000	1600 x 700	160	1139,-
CLASSIC PRO 170	9060000	1700 x 700	170	1295,-

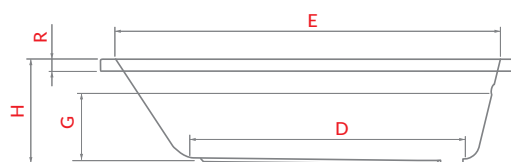
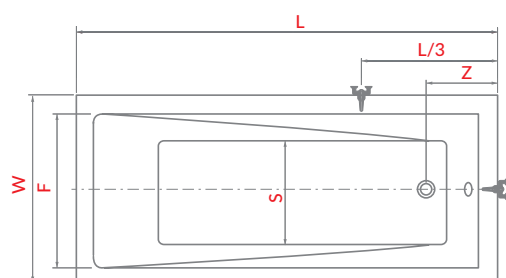

MODEL	L	W	H	G	D	R	E	F	Z
1500x700	1500	695	390	295	1080	35	1350	555	235
1600x700	1600	695	395	300	1170	35	1435	545	230
1700x700	1700	700	390	295	1240	35	1540	540	250

Nogi do wanien

NUMER KATALOGOWY	CENA NETTO
5139300	99,-

BRODZIKI

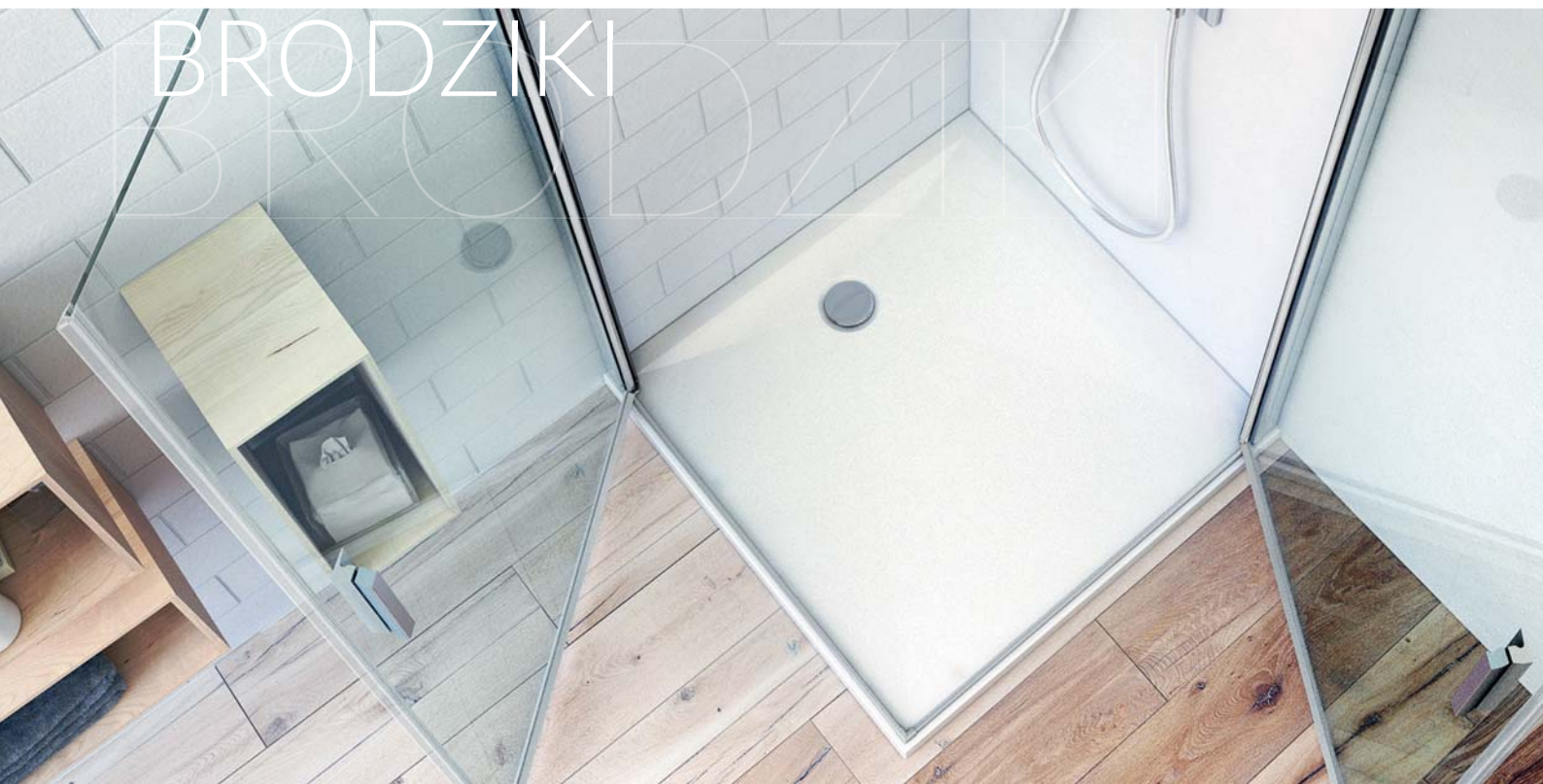

MARMO NEO

ROUND 80×80 / 90×90



Półokrągły brodzik z KOMPOZYTU MINERALNEGO

MODEL	NR KATALOGOWY	WYMIARY (mm)	CENA NETTO
Marmo Neo ROUND 800	MAN RO 080080 2E	800x800x30	699,-
Marmo Neo ROUND 900	MAN RO 090090 2E	900x900x30	731,-

MODEL	L	W	H1	H2	W1	E	S	R	Ø
800x800	800	800	30	110-130	250	45	180	550	90
900x900	900	900	30	110-130	350	45	180	550	90

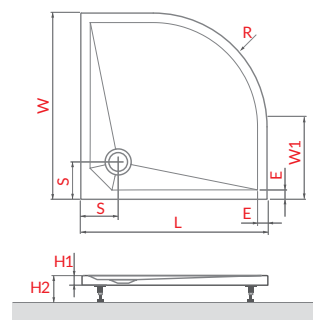

SQUARE 80×80 / 90×90

Kwadratowy brodzik z KOMPOZYTU MINERALNEGO

MODEL	NR KATALOGOWY	WYMIARY (mm)	CENA NETTO
Marmo Neo SQUARE 800	MAN SQ 080080 2E	800x800x30	699,-
Marmo Neo SQUARE 900	MAN SQ 090090 2E	900x900x30	731,-

MODEL	L	W	H1	H2	W1	E	S	Ø
800×800	800	800	30	110-130	250	45	180	90
900×900	900	900	30	110-130	350	45	180	90

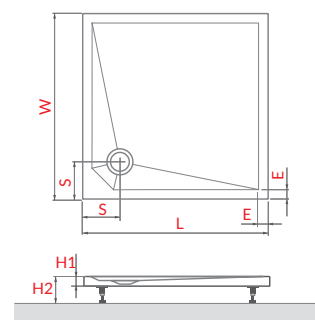

- 100×80 / 100×90
- 110×80 / 110×90
- 120×80 / 120×90
- 140×80 / 140×90
- 160×80 / 160×90

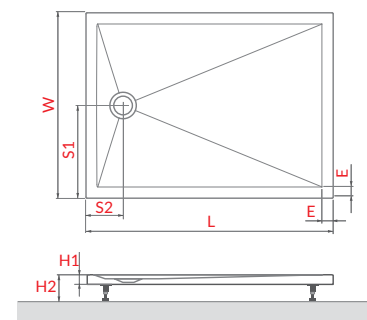
Prostokątny brodzik z KOMPOZYTU MINERALNEGO

MODEL	NR KATALOGOWY	WYMIARY (mm)	CENA NETTO
Marmo Neo SQUARE 100x80	MAN SQ 100080 2E	1000x800x30	785,-
Marmo Neo SQUARE 100x90	MAN SQ 100090 2E	1000x900x30	795,-
Marmo Neo SQUARE 110x80	MAN SQ 110080 2E	1100x800x30	790,-
Marmo Neo SQUARE 110x90	MAN SQ 110090 2E	1100x900x30	805,-
Marmo Neo SQUARE 120x80	MAN SQ 120080 2E	1200x800x35	831,-
Marmo Neo SQUARE 120x90	MAN SQ 120090 2E	1200x900x35	890,-
Marmo Neo SQUARE 140x80	MAN SQ 140080 2E	1400x800x35	967,-
Marmo Neo SQUARE 140x90	MAN SQ 140090 2E	1400x900x35	988,-
Marmo Neo SQUARE 160x80	MAN SQ 160080 2E	1600x800x35	1088,-
Marmo Neo SQUARE 160x90	MAN SQ 160090 2E	1600x900x35	1119,-

MODEL	L	W	H1	H2	E	S1	S2	Ø
1000×800	1000	800	30	110-130	50	400	180	90
1000×900	1000	900	30	110-130	50	450	180	90
1100×800	1100	800	30	110-130	50	400	180	90
1100×900	1100	900	30	110-130	50	450	180	90
1200×800	1200	800	35	115-135	50	400	180	90
1200×900	1200	900	35	115-135	50	450	180	90
1400×800	1400	800	35	115-135	50	400	180	90
1400×900	1400	900	35	115-135	50	450	180	90
1600×800	1600	800	35	115-135	50	400	180	90
1600×900	1600	900	35	115-135	50	450	180	90

MARIPOSA

MARIPOSA SAS



POWŁOKA OCHRONNA SZKŁA:
PROTECTIVE



SAS

DWUSKRZYDŁOWA ŚCIANKA SKŁADANA

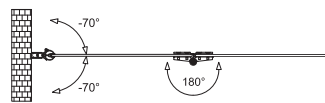
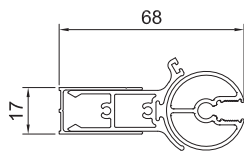
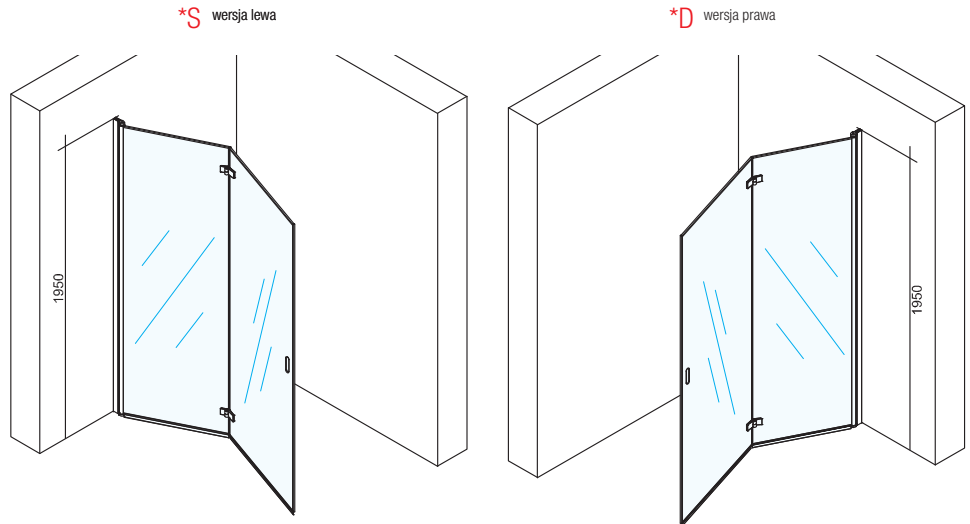
 Clear Glass
F

Ścianka MERIPOSA SAS

MODEL	SZEROKOŚĆ SKRZYDŁA (cm)	CENA NETTO		
		R	K	Z
MRSAS080*/_F	78,5 - 80,5	3189,-		3467,-
MRSAS090*/_F	88,5 - 90,5	3276,-		3555,-
MRSAS100*/_F	98,5 - 100,5	3360,-		3631,-
MRSAS110*/_F	108,5 - 110,5	3436,-		3713,-
MRSAS120*/_F	118,5 - 120,5	3520,-		3797,-



- » grubość szkła 6 mm – transparent (F)
- » wysokość 1950 mm
- » unoszony zawias
- » powłoka ochronna szkła PROTECTIVE

DOSTĘPNE KOLORY PROFILI:

 silver shining
Aluminium
R

 Matt
Silver
K

 Matt
Black
Z

ZEN SAO



POWŁOKA OCHRONNA SZKŁA:
PROTECTIVE

**ITALIAN
DESIGN**

ZEN SAO

ŚCIANKA STAŁA

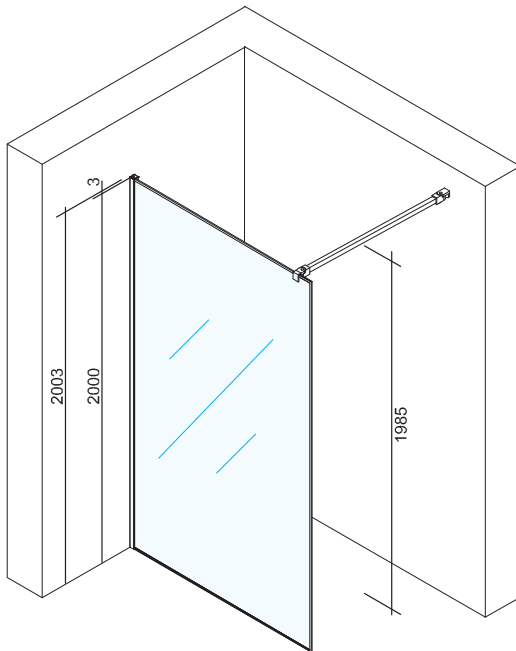

- » grubość szkła 6 mm – transparent (F)
- » wysokość 2000 mm
- » wspornik 1200 mm
- » powłoka ochronna szkła PROTECTIVE

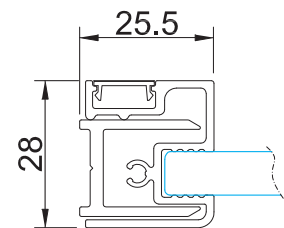
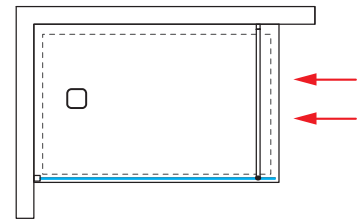

Clear Glass
F

Ścianka ZEN SAO

MODEL	SZEROKOŚĆ (cm)	CENA NETTO														
		Q	F	Z	E	B	A	4	3	D	9	7	W	8	I	
ZESA0080/_F	78 - 80		2851,-											5588,-		
ZESA0090/_F	88 - 90		2954,-											5676,-		
ZESA0100/_F	98 - 100		3049,-											5781,-		
ZESA0110/_F	108 - 110		3148,-											5869,-		
ZESA0120/_F	118 - 120		3242,-											5963,-		
ZESA0130/_F	128 - 130		3360,-											6082,-		
ZESA0140/_F	138 - 140		3489,-											6199,-		

DOSTĘPNE KOLORY PROFILI:

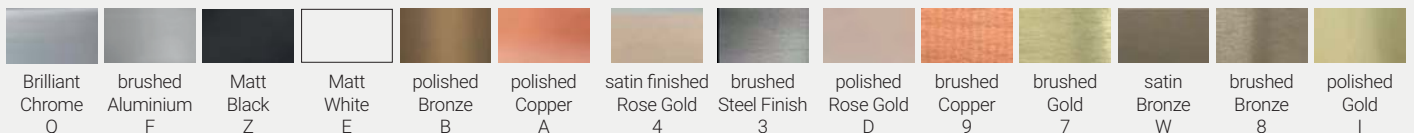

ETER
SAO



POWŁOKA OCHRONNA SZKŁA:
PROTECTIVE



ETER SAO

ŚCIANKA STAŁA

- » grubość szkła 8 mm – transparent (F)
- » wysokość 2000 mm,
- » wspornik 1200 mm
- » powłoka ochronna szkła PROTECTIVE

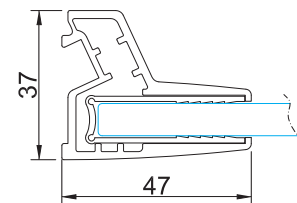
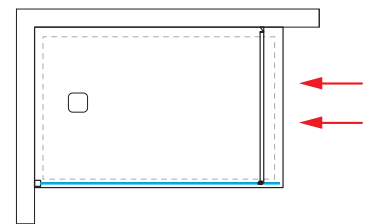
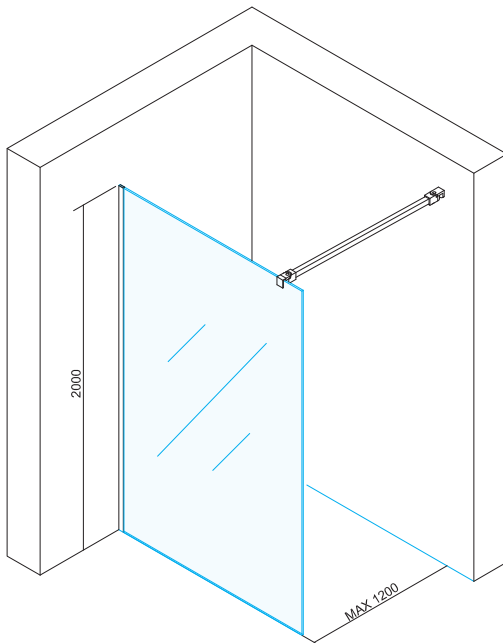

Clear Glass
F

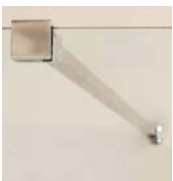

Ścianka ETER SAO ESTERO

MODEL	SZEROKOŚĆ (cm)	CENA NETTO												
		R	Z	B	A	4	3	D	9	7	W	8	I	
DUSA0070/_F	68,5 - 70,5	2573,-												4246,-
DUSA0080/_F	78,5 - 80,5	2695,-												4372,-
DUSA0090/_F	88,5 - 90,5	2820,-												4500,-
DUSA0100/_F	98,5 - 100,5	2939,-												4615,-
DUSA0110/_F	108,5 - 110,5	3067,-												4747,-
DUSA0120/_F	118,5 - 120,5	3197,-												4866,-
DUSA0130/_F	128,5 - 130,5	3337,-												5006,-
DUSA0140/_F	138,5 - 140,5	3467,-												5143,-
DUSA0150/_F	148,5 - 150,5	3646,-												5314,-
DUSA0160/_F	158,5 - 160,5	3809,-												5477,-

DOSTĘPNE KOLORY PROFILI:



silver shining
Aluminium
R



Matt
Black
Z



polished
Bronze
B



polished
Copper
A



satin finished
Rose Gold
4



brushed
Steel Finish
3



polished
Rose Gold
D



brushed
Copper
9



brushed
Gold
7



satin
Bronze
W



brushed
Bronze
8



polished
Gold
I

ZEN

ZEN P1



POWŁOKA OCHRONNA SZKŁA:
PROTECTIVE

**ITALIAN
DESIGN**

ZEN P1S

JEDNOSKRZYDŁOWE DRZWI PRZESUWNE DO WNĘKI

 Clear Glass
F

- » górny profil o wysokości zaledwie 17 mm,
- » grubość szkła 6 mm - transparent (F)
- » wysokość 2000 mm,
- » uchwyt o długości 580 mm
- » powłoka ochronna szkła PROTECTIVE

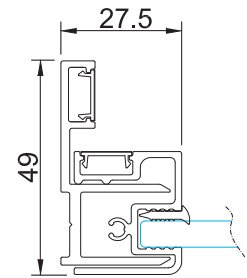
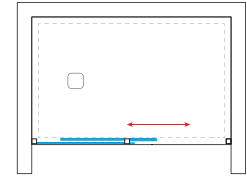
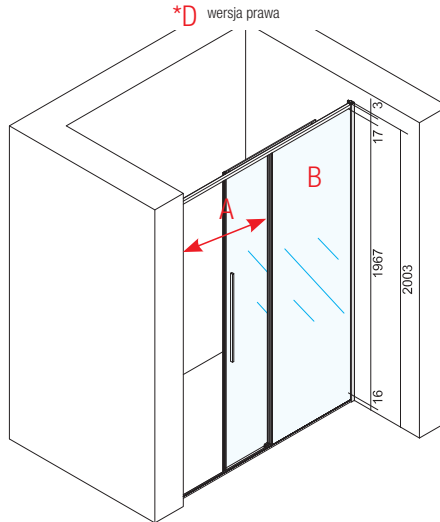
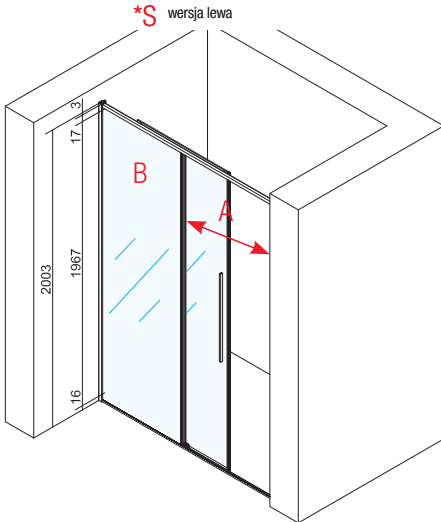

Drzwi przesuwne do wnąki ZEN P1S

MODEL	SZEROKOŚĆ (cm)	SZEROKOŚĆ WEJŚCIA (A)	SZEROKOŚĆ ŚCIANY STAŁEJ (B)	CENA NETTO																	
				Q	F	Z	E	B	A	4	3	D	9	7	W	8	I				
ZEP1S100*/_F	97 - 100	41	44					4728,-													7682,-
ZEP1S110*/_F	107 - 110	46	49					4839,-													7792,-
ZEP1S120*/_F	117 - 120	51	54					4956,-													7895,-
ZEP1S130*/_F	127 - 130	56	59					5086,-													8024,-
ZEP1S140*/_F	137 - 140	61	64					5192,-													8142,-
ZEP1S150*/_F	147 - 150	66	69					5321,-													8252,-
ZEP1S160*/_F	157 - 160	71	74					5440,-													8374,-



DOSTĘPNE KOLORY PROFILI:

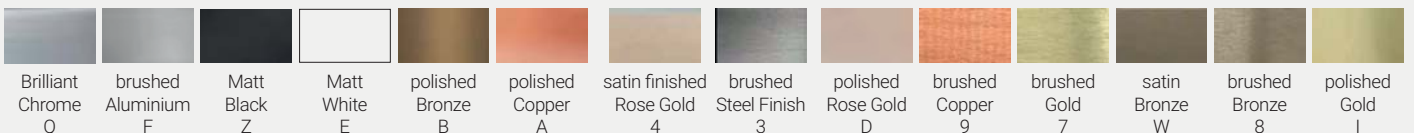

ZEN

ZEN

ALIS

**ITALIAN
DESIGN**



POWŁOKA OCHRONNA SZKŁA:
PROTECTIVE



ZEN A1S + FSO

JEDNOSKRZYDŁOWE DRZWI PRZESUWNE ZE ŚCIANKĄ BOCZNĄ

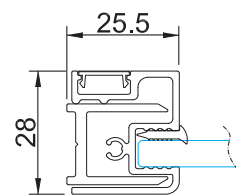
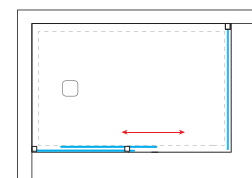
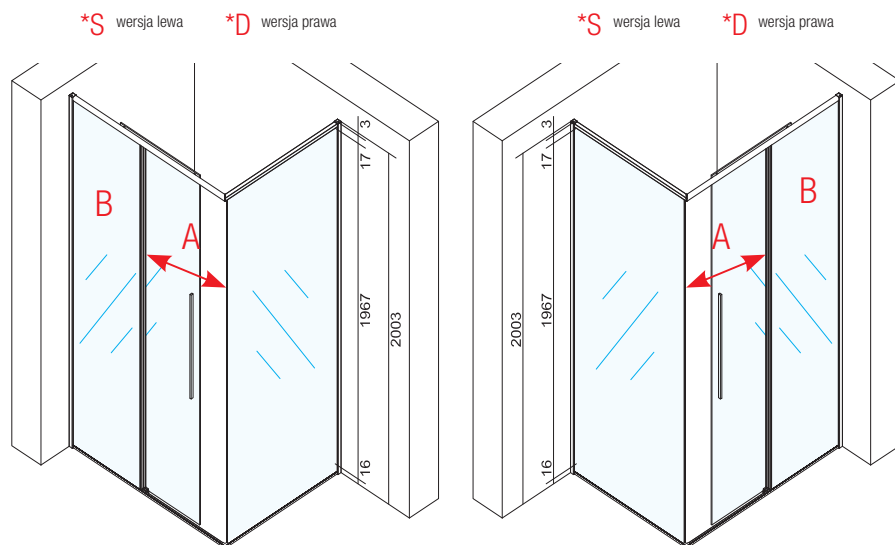
 Clear Glass
F

Drzwi przesuwne ZEN A1S

MODEL	SZEROKOŚĆ (cm)	SZEROKOŚĆ WEJŚCIA (A)	SZEROKOŚĆ ŚCIANY STAŁEJ (B)	CENA NETTO												
				Q	F	Z	E	B	A	4	3	D	9	7	W	8
ZEA1S100*/_F	98 - 100	43	45	4185,-				6473,-								
ZEA1S110*/_F	108 - 110	48	50	4291,-				6591,-								
ZEA1S120*/_F	118 - 120	53	55	4406,-				6694,-								
ZEA1S130*/_F	128 - 130	58	60	4531,-				6815,-								
ZEA1S140*/_F	138 - 140	63	65	4653,-				6928,-								
ZEA1S150*/_F	148 - 150	68	70	4763,-				7040,-								
ZEA1S160*/_F	158 - 160	73	75	4900,-				7173,-								

Ścianka boczna FSO

- » górny profil o wysokości zaledwie 17 mm,
- » grubość szkła 6 mm - transparent (F)
- » wysokość 2000 mm,
- » uchwyt o długości 580 mm
- » powłoka ochronna szkła PROTECTIVE

MODEL	SZEROKOŚĆ (cm)	CENA NETTO												
		Q	F	Z	E	B	A	4	3	D	9	7	W	8
ZEFS0070*/_F	68 - 70	2193,-				3592,-								
ZEFS0075*/_F	73 - 75	2254,-				3641,-								
ZEFS0080*/_F	78 - 80	2311,-				3690,-								
ZEFS0090*/_F	88 - 90	2413,-				3800,-								
ZEFS0100*/_F	98 - 100	2543,-				3926,-								
ZEFS0110*/_F	108 - 110	2664,-				4045,-								
ZEFS0120*/_F	118 - 120	2790,-				4169,-								

DOSTĘPNE KOLORY PROFILI:

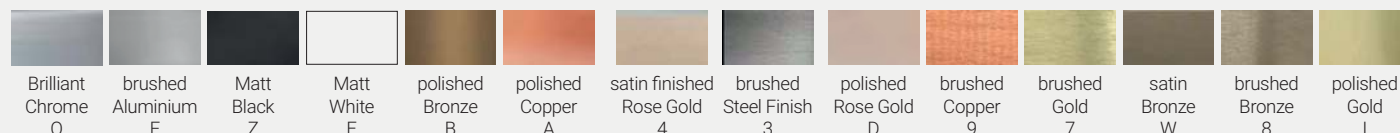

ZEN

ZEN
PVO



POWŁOKA OCHRONNA SZKŁA:
PROTECTIVE

**ITALIAN
DESIGN**

ZEN PV0+F00

JEDNOSKRZYDŁOWE DRZWI OTWIERANE DO WNĘKI LUB ŚCIANKI BOCZNEJ

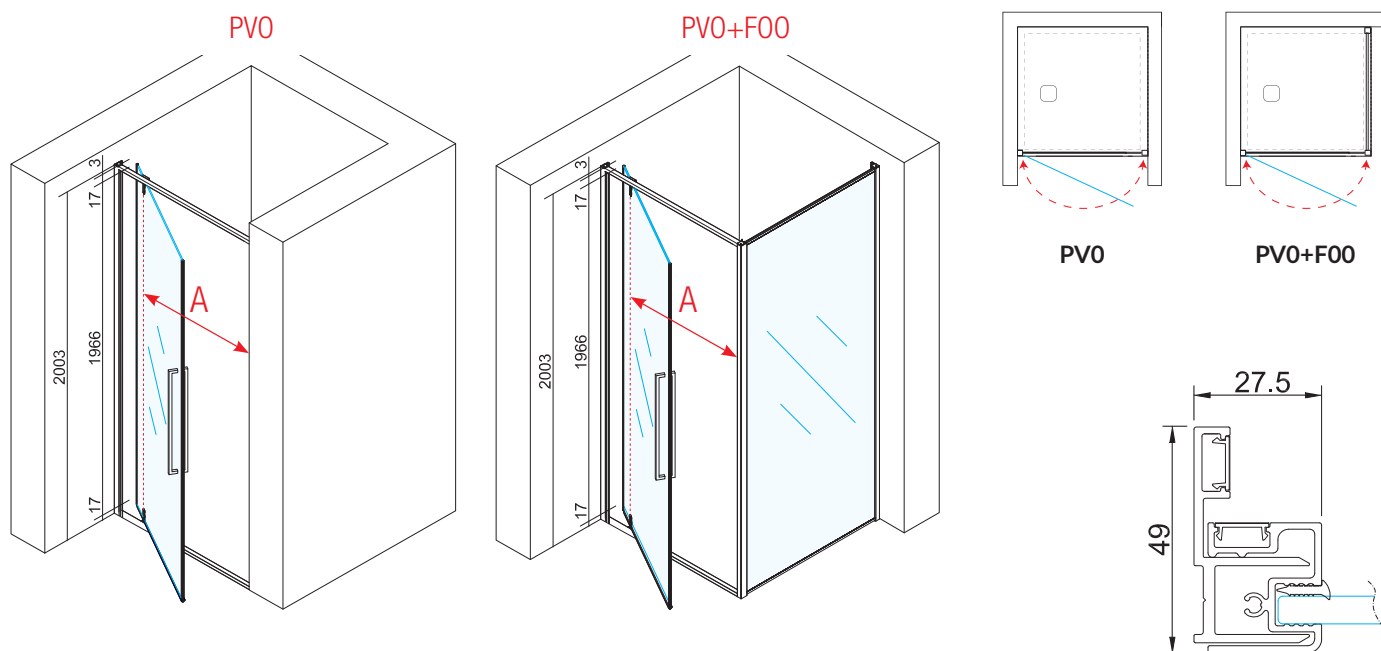

Drzwi otwierane ZEN PV0

MODEL	SZEROKOŚĆ (cm)	SZEROKOŚĆ WEJŚCIA (A)	CENA NETTO												
			Q	F	Z	B	A	4	3	D	9	7	W	8	I
ZEPV0070/_F	67 - 70	45	4668,-			6978,-									
ZEPV0075/_F	72 - 75	50	4724,-			7036,-									
ZEPV0080/_F	77 - 80	55	4789,-			7085,-									
ZEPV0090/_F	87 - 90	65	4889,-			7195,-									
ZEPV0100/_F	97 - 100	65	4967,-			7275,-									



Clear Glass
F

Ścianka boczna F00

MODEL	SZEROKOŚĆ (cm)	CENA NETTO												
		Q	F	Z	B	A	4	3	D	9	7	W	8	I
ZEF00070/_F	68 - 70	2300,-			3627,-									
ZEF00075/_F	73 - 75	2368,-			3679,-									
ZEF00080/_F	78 - 80	2421,-			3733,-									
ZEF00090/_F	88 - 90	2535,-			3850,-									
ZEF00100/_F	98 - 100	2649,-			3960,-									
ZEF00110/_F	108 - 110	2786,-			4086,-									
ZEF00120/_F	118 - 120	2912,-			4219,-									

- » profil górny o wysokości zaledwie 17 mm
- » szkło hartowane o grubości 6 mm
- » obecność profili zredukowana do minimum
- » wysokość 200 cm
- » powłoka ochronna szkła PROTECTIVE

DOSTĘPNE KOLORY PROFILI:

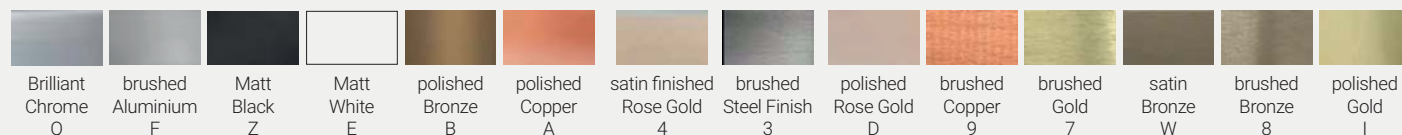

ZEN

ZEN PROTECTIVE



POWŁOKA OCHRONNA SZKŁA:
PROTECTIVE

**ITALIAN
DESIGN**

ZEN PVF

JEDNOSKRZYDŁOWE DRZWI OTWIERANE DO WNEKI

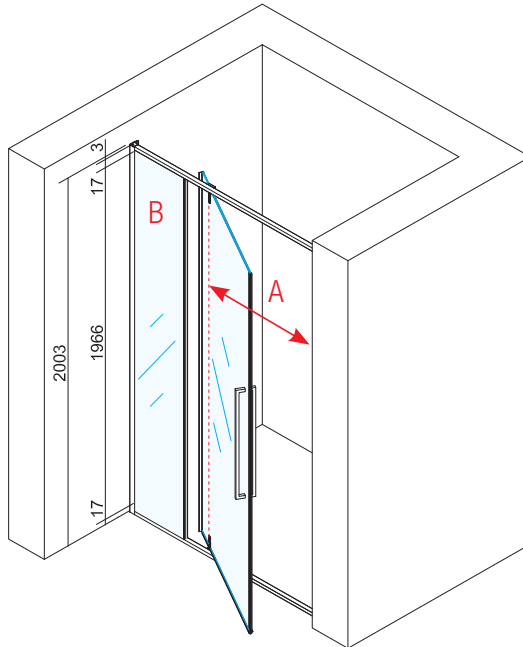
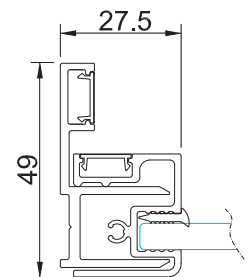
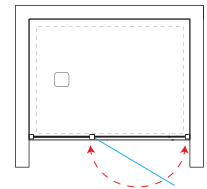

 Clear Glass
F

- » górny profil o wysokości zaledwie 17 mm,
- » grubość szkła 6 mm - transparent (F)
- » wysokość 2000 mm,
- » uchwyt o długości 580 mm
- » uniwersalna wersja lewa i prawa
- » powłoka ochronna szkła PROTECTIVE

Drzwi otwierane ZEN PVF

MODEL	SZEROKOŚĆ (cm)	SZEROKOŚĆ WEJŚCIA (A)	SZEROKOŚĆ ŚCIANY STAŁEJ (B)	CENA NETTO																
				Q	F	Z	E	B	A	4	3	D	9	7	W	8	I			
ZEPVF100/_F	97 - 100	50	29																5219,-	7792,-
ZEPVF110/_F	107 - 110	50	39																5325,-	7910,-
ZEPVF120/_F	117 - 120	55	44																5439,-	8016,-
ZEPVF130/_F	127 - 130	65	44																5561,-	8138,-
ZEPVF140/_F	137 - 140	65	54																5697,-	8259,-
ZEPVF150/_F	147 - 150	65	64																5824,-	8385,-
ZEPVF160/_F	157 - 160	65	74																5941,-	8511,-

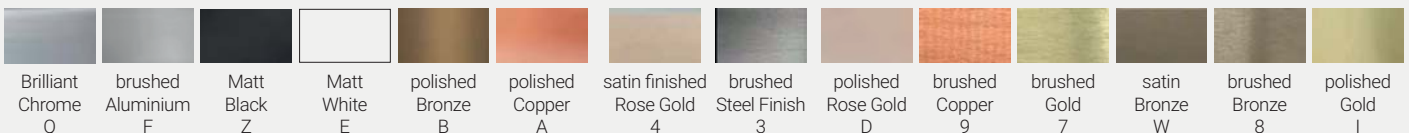
DOSTĘPNE KOLORY PROFILI:



ZEN

ZEN
A1B



 **ITALIAN
DESIGN** 



POWŁOKA OCHRONNA SZKŁA:
PROTECTIVE

ZEN A1B + FBO

JEDNOSKRZYDŁOWE DRZWI OTWIERANE ZE ŚCIANKĄ BOCZNĄ

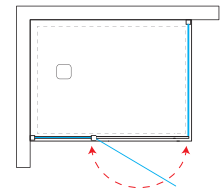
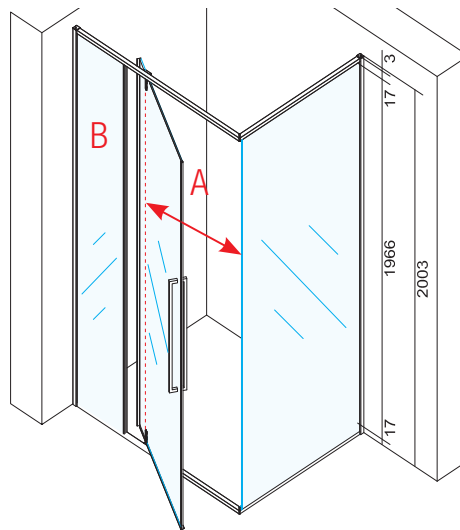

- » uniwersalna wersja lewa i prawa
- » górny profil o wysokości zaledwie 17 mm,
- » grubość szkła 6 mm – transparent (F)
- » wysokość 2000 mm,
- » uchwyt o długości 580 mm
- » powłoka ochronna szkła PROTECTIVE

Drzwi otwierane ZEN A1B

MODEL	SZEROKOŚĆ (cm)	SZEROKOŚĆ WEJŚCIA (A)	SZEROKOŚĆ ŚCIANY STAŁEJ (B)	CENA NETTO												
				Q	F	Z	E	B	A	4	3	D	9	7	W	8
ZEA1B100/_F	98 - 100	56	26	4622,-				7176,-								
ZEA1B110/_F	108 - 110	61	31	4744,-				7294,-								
ZEA1B120/_F	118 - 120	66	36	4869,-				7408,-								
ZEA1B130/_F	128 - 130	71	41	4990,-				7526,-								
ZEA1B140/_F	138 - 140	71	51	5116,-				7652,-								
ZEA1B150/_F	148 - 150	71	61	5237,-				7773,-								
ZEA1B160/_F	158 - 160	71	71	5428,-				7963,-								

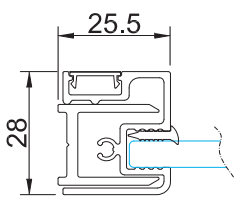

Clear Glass
F

Ścianka boczna FBO

MODEL	SZEROKOŚĆ (cm)	CENA NETTO												
		Q	F	Z	E	B	A	4	3	D	9	7	W	8
ZEFB0070/_F	68 - 70	2208,-				3603,-								
ZEFB0075/_F	73 - 75	2262,-				3657,-								
ZEFB0080/_F	78 - 80	2323,-				3710,-								
ZEFB0090/_F	88 - 90	2421,-				3816,-								
ZEFB0100/_F	98 - 100	2555,-				3937,-								
ZEFB0110/_F	108 - 110	2683,-				4059,-								
ZEFB0120/_F	118 - 120	2805,-				4185,-								

DOSTĘPNE KOLORY PROFILI:

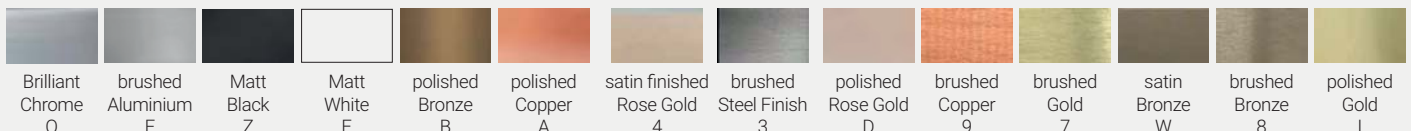

ZEN

ZEN
PCS

 **ITALIAN
DESIGN** 



POWŁOKA OCHRONNA SZKŁA:
PROTECTIVE

ZEN PCS

JEDNOSKRZYDŁOWE DRZWI PRZESUWNE DO WNĘKI

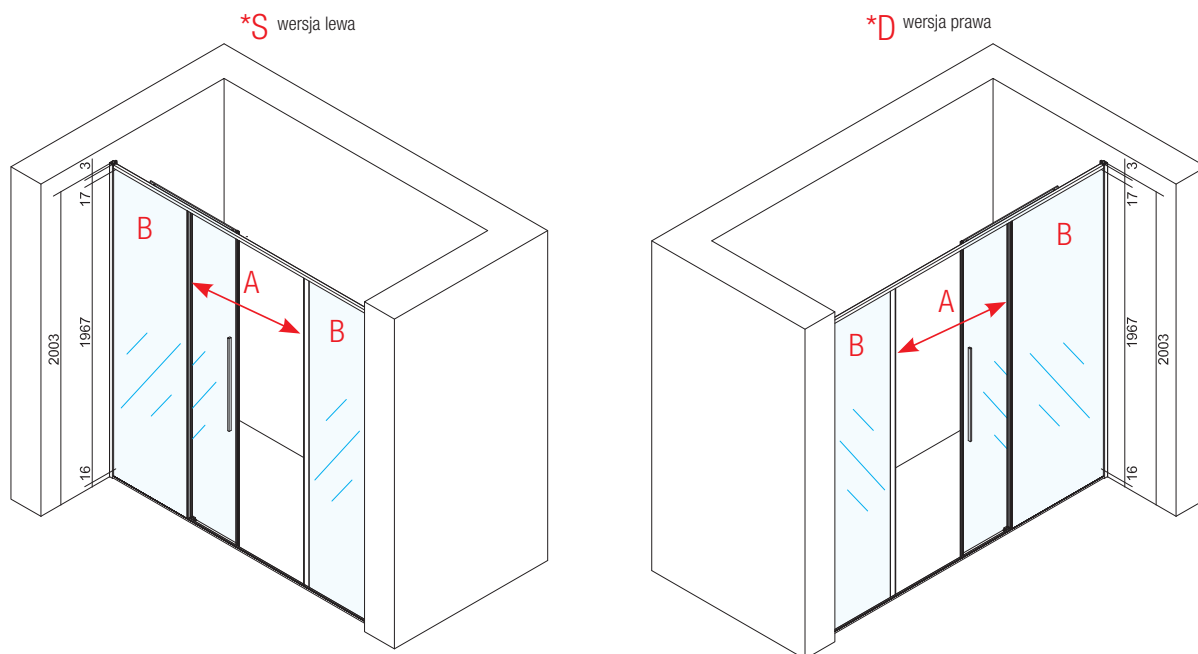

- » górny profil o wysokości zaledwie 17 mm,
- » grubość szkła 6 mm - transparent (F)
- » wysokość 2000 mm,
- » uchwyt o długości 580 mm
- » powłoka ochronna szkła PROTECTIVE

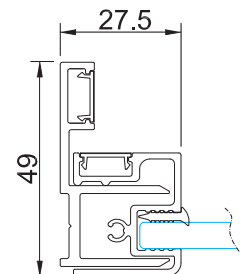
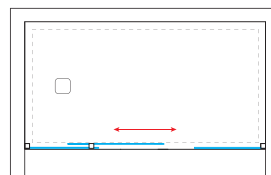
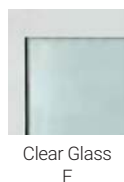

Drzwi przesuwne ZEN PCS

MODEL	SZEROKOŚĆ (cm)	SZEROKOŚĆ WEJŚCIA (A)	SZEROKOŚĆ ŚCIANY STAŁEJ (B)	CENA NETTO															
				Q	F	Z	E	B	A	4	3	D	9	7	W	8	I		
ZEPCS140*/_F	137 - 140	40	43															5656,-	8880,-
ZEPCS150*/_F	147 - 150	44	46															5797,-	9012,-
ZEPCS160*/_F	157 - 160	47	50															5934,-	9153,-

DOSTĘPNE KOLORY PROFILI:

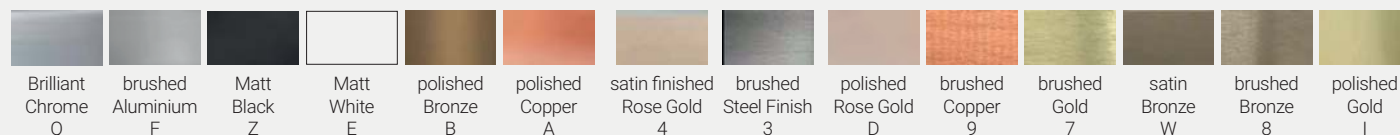

ZEN

ZEN
2S



POWŁOKA OCHRONNA SZKŁA:
PROTECTIVE

**ITALIAN
DESIGN**

ZEN P2S

PODWÓJNE DRZWI PRZESUWNE DO WNEKI

- » uniwersalna wersja lewa i prawa
- » górny profil o wysokości zaledwie 17 mm,
- » grubość szkła 6 mm – transparent (F)
- » wysokość 2000 mm,
- » uchwyt o długości 580 mm
- » powłoka ochronna szkła PROTECTIVE

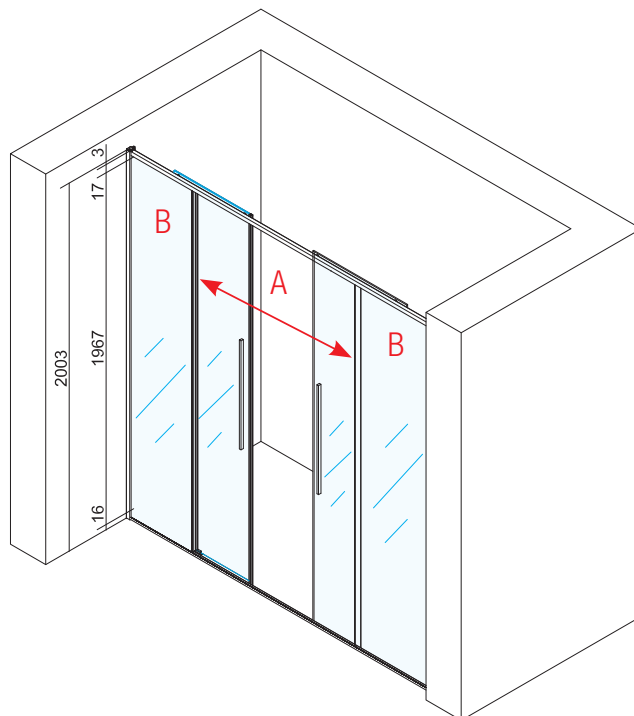

Clear Glass
F

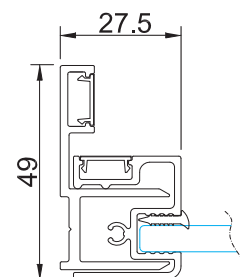
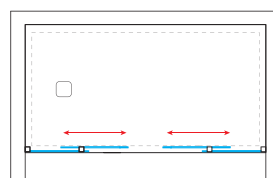

MODEL	SZEROKOŚĆ (cm)	SZEROKOŚĆ WEJŚCIA (A)	SZEROKOŚĆ ŚCIANY STAŁEJ (B)	CENA NETTO														
				Q	F	Z	E	B	A	4	3	D	9	7	W	8	I	
ZEP2S140/_F	137 - 140	58	31	6602,-				12034,-										
ZEP2S150/_F	147 - 150	62	34	6728,-				12159,-										
ZEP2S160/_F	157 - 160	66	36	6860,-				12293,-										

DOSTĘPNE KOLORY PROFILI:

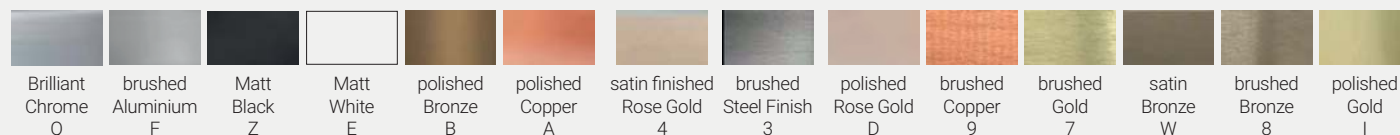

CERAMIKA

CERAMIKA

PLUSSTON



**ITALIAN
DESIGN**

CERAMICA
ALTHEA**INNOWACJA PLUS+TON®**

Uzyskiwany z jednego procesu
stapiania w temperaturze 1250°,
PLUS+TON® to:

- » powłoka zapobiegająca
zbieraniu się wody
- » w 100% odporna
na zarysowania
- » antypoślizgowa
- » plamoodporna
- » odporna na bakterie
- » produkcja wyłącznie
przy użyciu naturalnych
surowców najwyższej jakości

**NOWOŚĆ****plus-ton®****CERAMIKA BARWIONA W MASIE**

COVER RIMLESS GLOSS WHITE

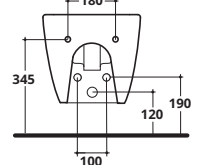
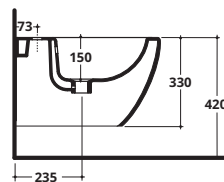
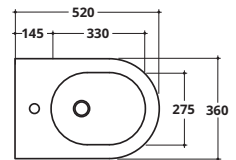
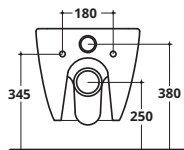
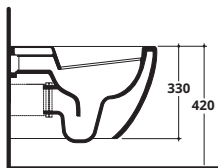
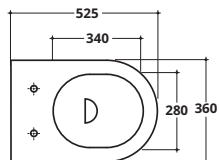

NR KATALOGOWY	OPIS	CENA NETTO
CV013 + CV007S + 40951	COVER RIMLESS miska WC + deska wolnoopadająca SLIM + mocowanie	1439,-

NR KATALOGOWY	OPIS	CENA NETTO
CV004 + 40951	COVER bidet wiszący + mocowanie	1139,-

COVER RIMLESS **PLUS+TON**



#01



#02



#03



#05



#06



#09

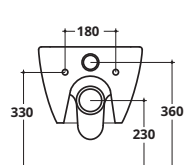
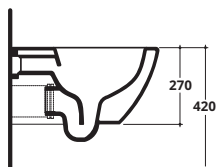
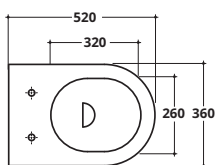

NR KATALOGOWY

OPIS

CENA NETTO

40375R.#
+ 41113.#
+ 40951

COVER RIMLESS
miska WC (PLUS+TON)
+ deska wolnoopadająca SLIM
+ mocowanie

2929,-

plus+ton®

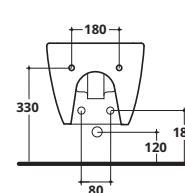
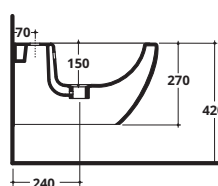
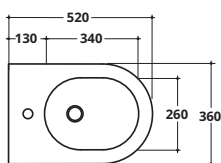

NR KATALOGOWY

OPIS

CENA NETTO

40373R.# + 40951

COVER
bidet wiszący (PLUS+TON)
+ mocowanie

1999,-

plus+ton®

INNOWACJA

plus+ton®

plus+ton® COLOURS



BIANCO
#01

LINO
#02*

CEMENTO
#03*

FERRO
#05*

BEIGE
#06

NERO
#09

* KOLOR DOSTĘPNY NA ZAMÓWIENIE

COVER 58 x 30

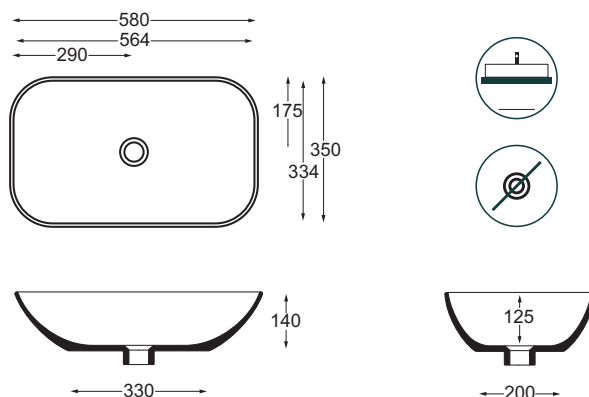

NR KATALOGOWY	OPIS	CENA NETTO
40234	Umywarka 580 x 350 mm	1219,-

NR KATALOGOWY	OPIS	CENA NETTO
40234.#	Umywarka 580 x 350 mm (PLUS+TON)	1629,-

plus+ton

COVER 70 x 35

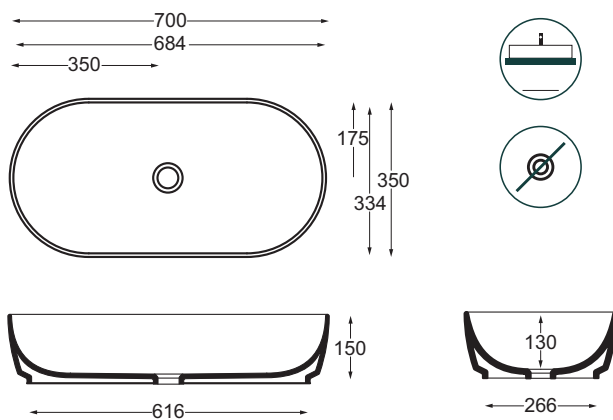

NR KATALOGOWY	OPIS	CENA NETTO
40583	Umywarka 700 x 350 mm	1299,-

NR KATALOGOWY	OPIS	CENA NETTO
PCV70A.#	Umywarka 700 x 350 mm (PLUS+TON)	2029,-

plus+ton

AKCESORIA

NR KATALOGOWY	OPIS	CENA NETTO
CCNEWNTP	Korek CLICK-CLACK bez przelewu (CERAMICZNY)	291,-
PCCNEWNTP#	Korek CLICK-CLACK bez przelewu (PLUS+TON)	339,- plus+ton



CCNEWNTP
CERAMICZNY



PCCNEWNTP
PLUS+TON

bez przelewu

KASSEL

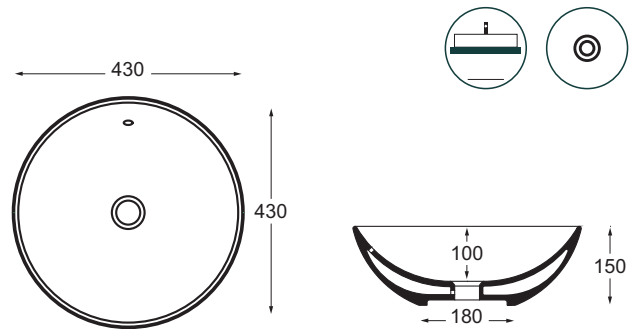

NR KATALOGOWY	OPIS	CENA NETTO
41112	Umywalka z przelewem 430 x 430 mm	1139,-

NR KATALOGOWY	OPIS	CENA NETTO
41112.#	Umywalka z przelewem 430 x 430 mm (PLUS+TON)	1499,-

plus+ton

UP

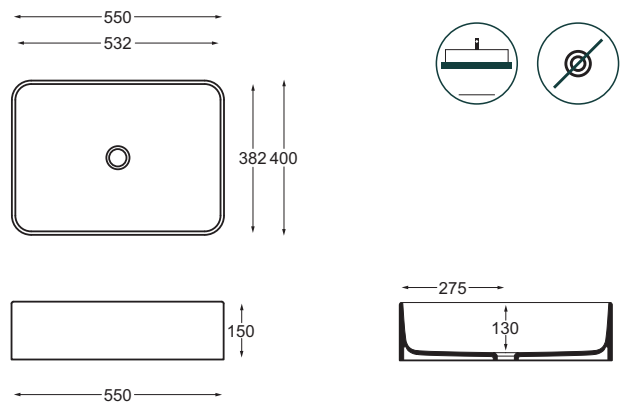

NR KATALOGOWY	OPIS	CENA NETTO
40884	Umywalka 550 x 400 mm	1499,-

NR KATALOGOWY	OPIS	CENA NETTO
PUP.#	Umywalka 550 x 400 mm (PLUS+TON)	1869,-

plus+ton

AKCESORIA

NR KATALOGOWY	OPIS	CENA NETTO
CCNEW	Korek CLICK-CLACK z przelewem (CERAMICZNY)	291,-
PCCNEW.#	Korek CLICK-CLACK z przelewem (PLUS+TON)	339,- plus+ton



CCNEW
CERAMICZNY



PCCNEW
PLUS+TON

z przelewem

UP UP

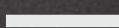

plus+ton COLOURS



BIANCO
#01



LINO
#02



CEMENTO
#03



FERRO
#05



BEIGE
#06



NERO
#09

* KOLOR DOSTĘPNY NA ZAMÓWIENIE

UP - CERAMICZNY

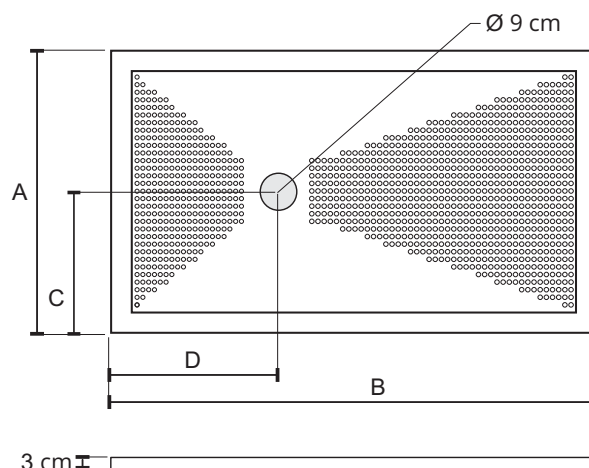
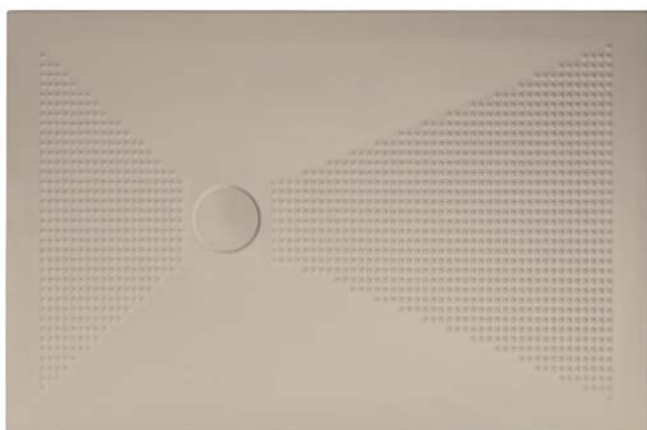

UP 70

MODEL	A x B (cm)	C (cm)	D (cm)	Waga (kg)	CENA NETTO	
					○ GLOSS WHITE	⊕ PLUS+TON
○ UPC79 ⊕ UPCM79	70 x 90	35	26	22	1369,-	1924,-
○ UPC710 ⊕ UPCM710	70 x 100	35	31	24	1465,-	2141,-
○ UPC712 ⊕ UPCM712	70 x 120	35	41	26	1868,-	2738,-
○ UPC714 ⊕ UPCM714	70 x 140	35	51	31	2366,-	3050,-

UP 80

MODEL	A x B (cm)	C (cm)	D (cm)	Waga (kg)	CENA NETTO	
					○ GLOSS WHITE	⊕ PLUS+TON
○ UPC88 ⊕ UPCM88	80 x 80	40	40	20	1400,-	1960,-
○ UPC810 ⊕ UPCM810	80 x 100	40	31	25	1556,-	2459,-
○ UPC812 ⊕ UPCM812	80 x 120	40	41	34	2114,-	2939,-
○ UPC814 ⊕ UPCM814	80 x 140	40	51	36	2614,-	3436,-

UP 90

MODEL	A x B (cm)	C (cm)	D (cm)	Waga (kg)	CENA NETTO	
					○ GLOSS WHITE	⊕ PLUS+TON
○ UPC912 ⊕ UPCM912	90 x 120	45	41	36	2366,-	3274,-
○ UPC914 ⊕ UPCM914	90 x 140	45	51	39	2863,-	3859,-
○ UPC916 ⊕ UPCM916	90 x 160	45	61	45	3361,-	4406,-

KOMFORTOWY Z FUNKCJĄ MASAŻU

WYPALANY Z DROBNEJ GLINKI CERAMICZNEJ

MOŻLIWOŚĆ MONTAŻU Z KAŻDEJ KRAWĘDZI

ANTYPOŚLIZGOWA STRUKTURA

MOŻLIWOŚĆ DOCIĘCIA

dostępne w kolorach plus+ton lub biały potysk CERAMICZNY

MONTAŻ NA POSADZCE ZLICOWANY Z POZIOMEM PŁYTEK

AKCESORIA

NR KATALOGOWY	OPIS	CENA NETTO
SCPD90C#BL	Syfon Ø 9 cm (CERAMICZNA POKRYWA)	282,-
SCPD90C.#	Syfon Ø 9 cm (POKRYWA PLUS+TON)	328,- plus+ton



SCPD90C#BL
CERAMICZNA POKRYWA



SCPD90C
PLUS+TON

AZZURRA

DESIGN I FUNKCJONALNOŚĆ





**ITALIAN
DESIGN**





CRISTAL
CRISTAL



CRISTAL

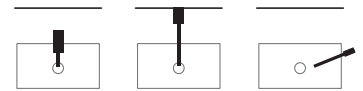
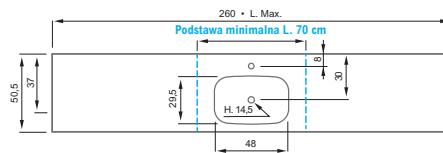
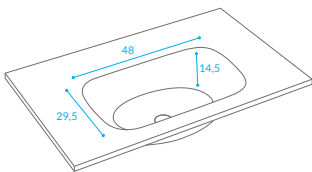

- » grubość blatu 10 mm
- » wymiary miski umywalki: 480 x 295 x 145 mm
- » duża gama kolorystyczna
- » dwa rodzaje wykończenia: połysk i mat
- » max. długość blatu 2600 mm
- » możliwość umiejscowienia miski umywalkowej: centralnie, po lewej lub prawej stronie



SPOSÓB WYCENY

DŁUGOŚĆ BLATU
 x CENA 1 MB BLATU
 = CENA BLATU
 +
 CENA UMYWALKI
 =
 CENA BLATU
 ZE ZINTEGROWANĄ
 UMYWALKĄ

BLAT ZE SZKŁA HARTOWANEGO (grubość 10 mm)

GŁĘBOKOŚĆ (cm)	NUMER KATALOGOWY	CENA NETTO POŁYSK	CENA NETTO MAT
50	TM01046	2830,-*	3768,-*

* cena netto za 1 mb blatu

ZINTEGROWANA UMYWALKA

WYMIARY MISY (cm)	NUMER KATALOGOWY	CENA NETTO POŁYSK	CENA NETTO MAT
48 x 29,5 x 14,5	T1FL010	2410,-	2720,-

TOP SIT OF BASIN



**ITALIAN
DESIGN**

TOP SIT OF BASIN
TOP SIT OF

TOP SIT



- » grubość blatu 10-12 mm
- » duża gama kolorystyczna



GŁĘBOKOŚĆ (cm)	SZEROKOŚĆ (cm)	NUMER KATALOGOWY	CENA NETTO DEKORATIVO 3D	CENA NETTO WHITE MATT / WHITE GLOSSY	CENA NETTO COLOURS MATT	CENA NETTO COLOURS GLOSSY - SOFT TOUCH	CENA NETTO HPL	CENA NETTO WOOD - ESSENZE
50,5	60,4	TM01051	288,-	474,-	545,-	617,-	434,-	617,-
	70,4	TM01051	336,-	552,-	635,-	719,-	506,-	719,-
	80,4	TM01051	384,-	630,-	726,-	821,-	578,-	821,-
	90,4	TM01051	432,-	709,-	816,-	923,-	650,-	923,-
	105,4	TM01051	503,-	827,-	951,-	1076,-	757,-	1076,-
	120,4	TM01051	575,-	944,-	1087,-	1229,-	865,-	1229,-

PLUS WYKONANIE OTWORU NA UMYWALKĘ

		T1FT000	232,-	232,-	232,-	232,-	232,-	232,-
--	--	---------	-------	-------	-------	-------	-------	-------

CORTECCIA – WOOD TOP



CORTECCIA

WOOD TOP



CORTECCIA



- » grubość blatu 60 mm
- » duża gama oklein drewnianych



ROVERE Bianco



ROVERE Naturale



ROVERE Sabbla



ROVERE Cenere



ROVERE Avena



ROVERE Fumo



ROVERE Carbone



ROVERE Moka



ROVERE Nero

BLAT DREWNIANY (forniowany)

GRUBOŚĆ (cm)	GŁĘBOKOŚĆ (cm)	NUMER KATALOGOWY	CENA NETTO
6	51	TMB6051	2922,-*
PLUS WYKONANIE OTWORU NA UMYWALKĘ			* cena netto za 1 mb blatu
		T1FT000	255,-

LIME 2.0

**ITALIAN
DESIGN**



LIME 2.0

LIME 2.0



- » Szafka pod umywalkę – 2 szuflady.
- » Wysokość 56 cm.
- » Wysokość szuflad 25 cm.
- » Szeroka gama wykończenia.
- » Elementy mebli wykonane są z płyt o grubości 1,8 cm.
- » Wysoka odporność na działanie wody V100.
- » Wszystkie lakiery bez metali ciężkich w składzie. Baza wodna. Certyfikat FSC.
- » Prowadnice i zawiasy szwajcarskiej firmy GRASS.
- » Listwy wzmacniające korpus wykonane są z aluminium.
- » System mocowania/wieszania z rozbudowanymi możliwościami niwelowania krzywizn na ścianie.
- » Elementy lakierowane mają minimum 7 warstw natrysku koloru.
- » Środki szuflad wyściełane specjalnym materiałem skóropodobnym.
- » 30 miesięcy gwarancji.

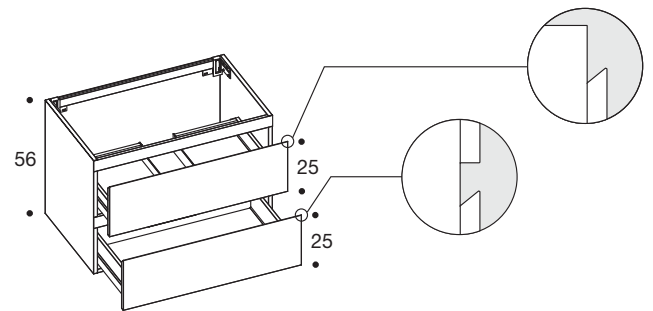

RIGATINO Naturale

RIGATINO Tabacco

RIGATINO Beton



GŁĘBOKOŚĆ (cm)	SZEROKOŚĆ (cm)	NUMER KATALOGOWY	CENA NETTO DEKORATIVO 3D RIGATINO	CENA NETTO WHITE MATT / WHITE GLOSSY	CENA NETTO COLOURS MATT	CENA NETTO HPL	CENA NETTO WOOD - ESSENZE
50,5	60	G1NB56605	2721,-	2970,-	3417,-	3759,-	3759,-
	70	G1NB56705	2988,-	3255,-	3728,-	4114,-	4114,-
	80	G1NB56805	3141,-	3426,-	3925,-	4346,-	4346,-
	90	G1NB56905	3303,-	3601,-	4118,-	4578,-	4578,-
	105	G1NB56A55	3527,-	3855,-	4416,-	4915,-	4915,-
	120	G1NB56C05	3715,-	4061,-	4653,-	5213,-	5213,-

**ITALIAN
DESIGN**



SYNTEZI

SYNTEZI 51



POJEDYŃCZA

WYMIARY KOMORY (cm)	SZEROKOŚĆ SZAFKI (cm)	NUMER KATALOGOWY	CENA NETTO
32 48	60	TCNSA60	1323,-
32 58	70	TCNSA70	1476,-
32 58	80	TCNSA80	1625,-
32 58	90	TCNSA90	1752,-
32 58	105	TCNSAA0	1866,-
32 58	120	TCNSACO	2111,-
32 58	105 MODUŁY 70+35	TCNSCAS	2229,-
32 58	105 MODUŁY 35+70	TCNSCAD	2229,-
32 58	120 MODUŁY 70+50	TCNSCCS	2444,-
32 58	120 MODUŁY 50+70	TCNSCCD	2444,-

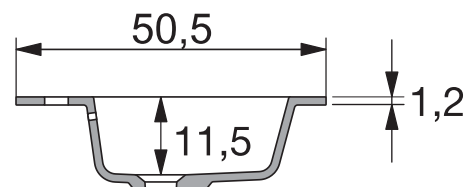

**BIAŁY
POŁYSK**
 - TAN -

**BIAŁY
MAT**
 - TAP -

PALAZZANI

MIDI
MIDI



**ITALIAN
DESIGN**

CHROMOWANE



10
Chrome

KOLORY MATOWE



39
graphite
matt Black

TECHNOLOGIA PVD KOLOR



79
polish
Nickel



80
brushed
Steel



81
polish
dark Nickel



82
brushed
dark Nickel



83
polish
Gold



84
brushed
Brass



85
polish
rose Gold



86
brushed
rose gold



87
polish
champagne Gold



88
brushed
champagne Gold



89
brushed
copper Bronze



NOWOŚĆ

- » nowoczesna technologia **PVD KOLOR**
- » powierzchnia antyalergiczna i antybakteryjna
- » grubość warstwy z kolorem minimum 20 mikronów
- » bardzo twarda powierzchnia odporna na czynniki zewnętrzne
- » brak skłonności do korozji
- » odporność na odbarwienia, uszkodzenia i ścieranie



MIDI
MIDI

 **ITALIAN**
DESIGN 

023045

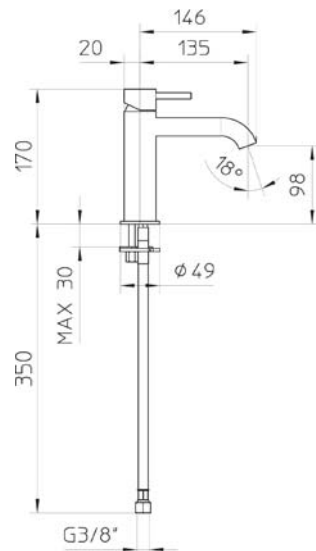

MIDI
Bateria umywalkowa bez korka

NUMER KATALOGOWY	CENA NETTO
023045 10	500,-
023045 39	785,-
023045 79 80 81 82 83 84 85 86 87 88 89	853,-

024111

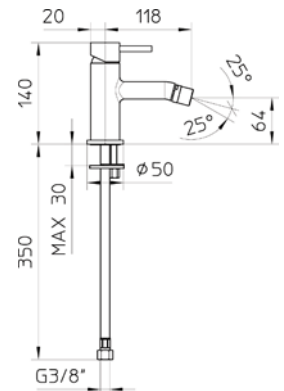

MIDI
Bateria bidetowa bez korka

NUMER KATALOGOWY	CENA NETTO
024111 10	430,-
024111 39	667,-
024111 79 80 81 82 83 84 85 86 87 88 89	749,-

023018



MIDI
Bateria umywalkowa wysoka bez korka

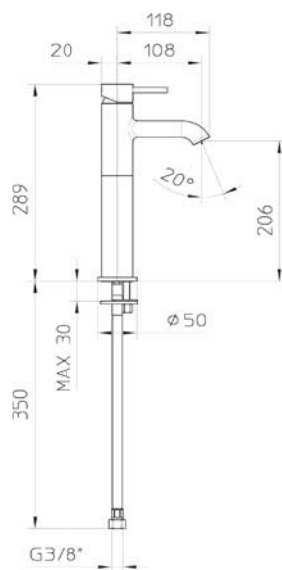

NUMER KATALOGOWY	CENA NETTO
023018 10	625,-
023018 39	1015,-
023018 79 80 81 82 83 84 85 86 87 88 89	1121,-





995720 + 123195

MIDI
Bateria umywalkowa podtynkowa
ścienna

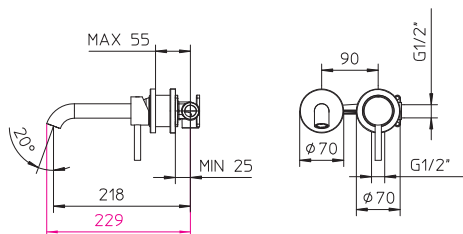

NUMER KATALOGOWY

CENA NETTO

995720 + 123195 10	999,-
995720 + 123195 39	1349,-
995720 + 123195 79 80 81 82 83 84 85 86 87 88 89	1499,-

995720 + 123289

MIDI
Bateria umywalkowa podtynkowa
ścienna

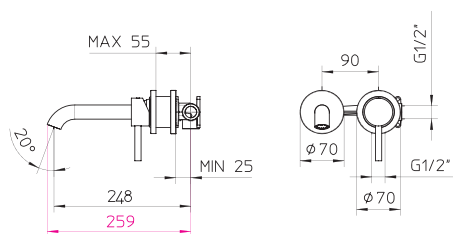

NUMER KATALOGOWY

CENA NETTO

995720 + 123289 10	1069,-
995720 + 123289 39	1449,-
995720 + 123289 79 80 81 82 83 84 85 86 87 88 89	1585,-

121089

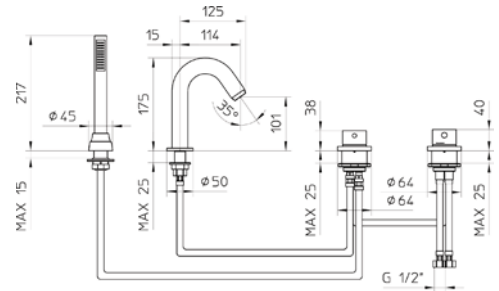

MIDI

Bateria wannowa 4-otworowa

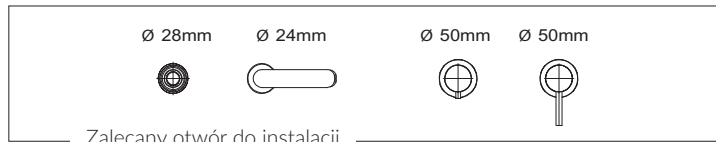

NUMER KATALOGOWY

CENA NETTO

121089 10	2162,-
121089 39	3267,-
121089 79 80 81 82 83 84 85 86 87 88 89	3739,-

995715 + 122178

MIDI

Mieszacz

(1 ujęcie - komplet)

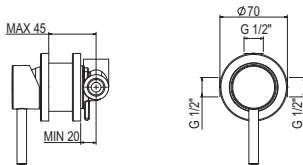

NUMER KATALOGOWY

CENA NETTO

995715 + 122178 10	688,-
995715 + 122178 39	901,-
995715 + 122178 79 80 81 82 83 84 85 86 87 88 89	980,-

021015

MIDI

Bateria wannowa

ścienna

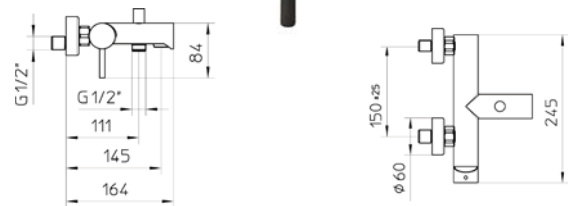

NUMER KATALOGOWY

CENA NETTO

021015 10	669,-
021015 39	1049,-
021015 79 80 81 82 83 84 85 86 87 88 89	1179,-

995735 + 122261

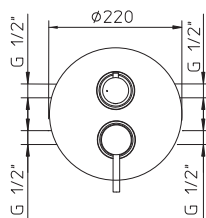

MIDI

Bateria podtynkowa

z mieszaczem

i przełącznikiem funkcji

(2 ujęcia - komplet)

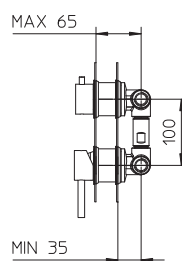

NUMER KATALOGOWY

CENA NETTO

995735 + 122261 10	1532,-
995735 + 122261 39	1966,-
995735 + 122261 79 80 81 82 83 84 85 86 87 88 89	2085,-

992773 + 962604

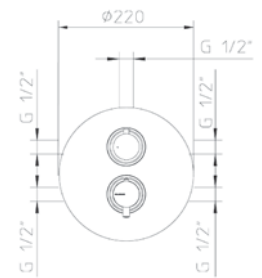

MIDI

Bateria podtynkowa z termostatem

(2 ujęcia - komplet)

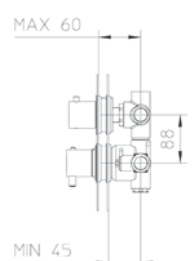

NUMER KATALOGOWY

CENA NETTO

992773 + 962604 10	2284,-
992773 + 962604 39	2796,-
992773 + 962604 79 80 81 82 83 84 85 86 87 88 89	2954,-



 **ITALIAN**
DESIGN 

MIDI

MIDI

ZESTAWY NATRYSKOWE

9958B4

Ramię ścienne,
długość 350 mm

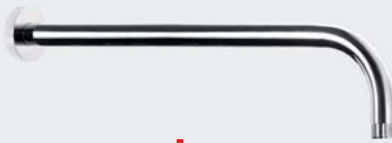

+

Deszczownica
okrągła Ø 200 mm
MOSIĄDZ



+

Zestaw:
złącze kątowe ścienne,
wąż, słuchawka **MOSIĄDZ**



9958B4

Ramię ścienne,
długość 350 mm



+

Deszczownica
okrągła Ø 200 mm
MOSIĄDZ



+

Zestaw:
złącze kątowe ścienne,
wąż, słuchawka **MOSIĄDZ**



122178 + 995715



+

MIDI
2 x mieszacz + 2 x element podtynkowy
UNICO 1-ujście 1/2"

OPIS	CENA NETTO
Zestaw CHROM	2366,-
Zestaw KOLOR MAT	4089,-
Zestaw KOLOR PVD	4744,-

022327
+ 995715

MIDI
Przełącznik funkcji
+ element podtynkowy
UNICO 2-ujście 1/2"



+

122178 + 995715

MIDI
Mieszacz + element podtynkowy
UNICO 1-ujście 1/2"



OPIS	CENA NETTO
Zestaw CHROM	2406,-
Zestaw KOLOR MAT	4129,-
Zestaw KOLOR PVD	4784,-

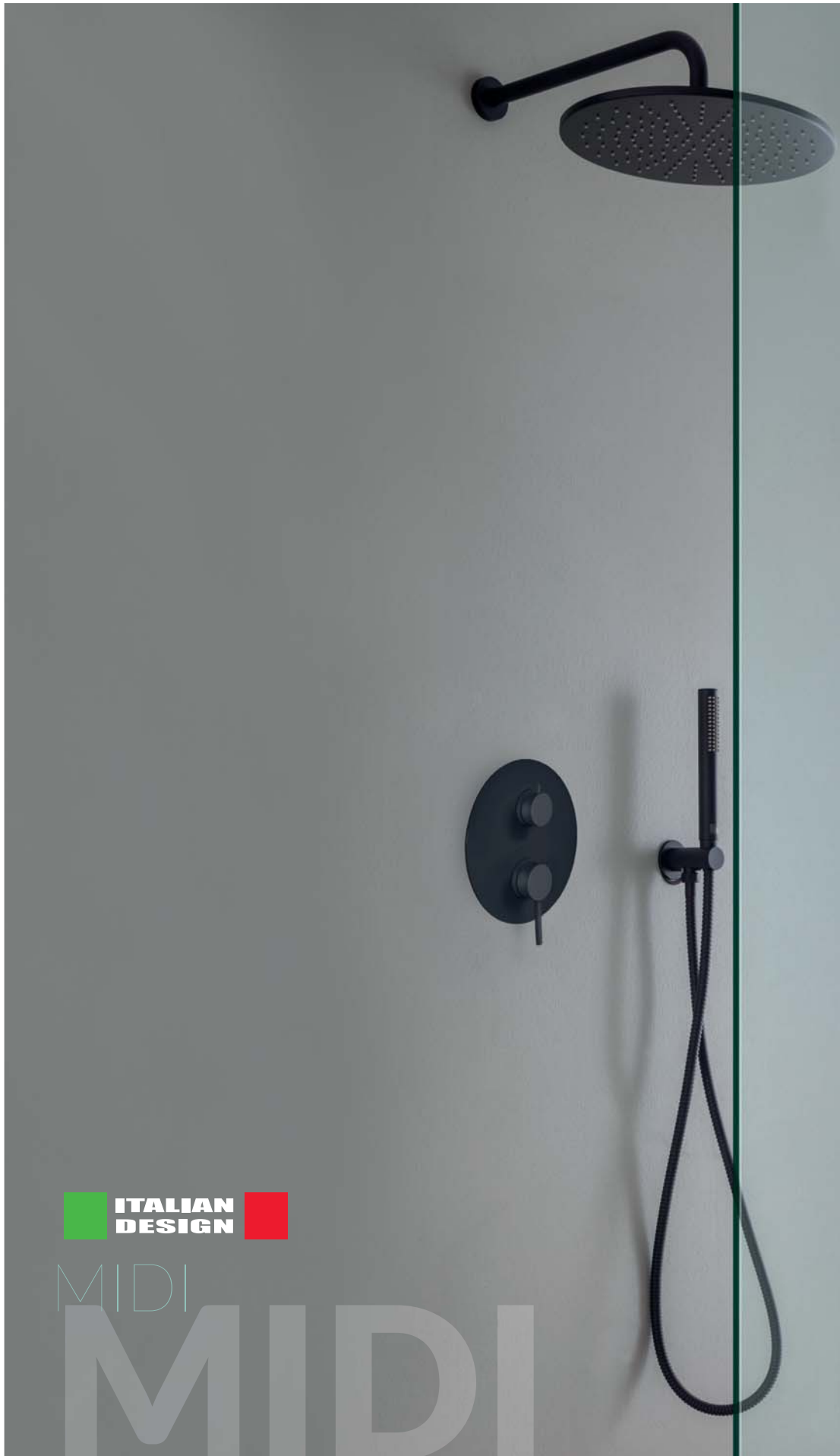

**ITALIAN
DESIGN**

MIDI
MIDI

ZESTAWY NATRYSKOWE

9958B4

Ramię ścienne,
długość 350 mm

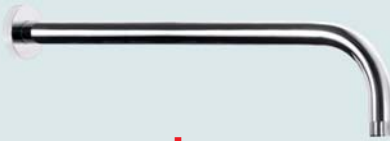

Deszczownica
okrągła Ø 200 mm
MOSIĄDZ



Zestaw:
złącze kątowe ścienne,
wąż, słuchawka **MOSIĄDZ**



9958B4

Ramię ścienne,
długość 350 mm



Deszczownica
okrągła Ø 200 mm
MOSIĄDZ



Zestaw:
złącze kątowe ścienne,
wąż, słuchawka **MOSIĄDZ**



122261
+ 995735

MIDI
bateria podtynkowa z mieszaczem
i przełącznikiem funkcji
+ element podtynkowy
UNICO 2-ujścia 1/2"



OPIS	CENA NETTO
Zestaw CHROM	2522,-
Zestaw KOLOR MAT	4253,-
Zestaw KOLOR PVD	4869,-

962604
+ 992773

MIDI
bateria podtynkowa z termostatem
+ element podtynkowy
UNICO 2-ujścia 1/2"



OPIS	CENA NETTO
Zestaw CHROM	3274,-
Zestaw KOLOR MAT	5083,-
Zestaw KOLOR PVD	5738,-

MIDI



MIDI



99571799 + 121179

MIDI

bateria wannowa podłogowa z podłogowym elementem montażowym, wąż flexi.

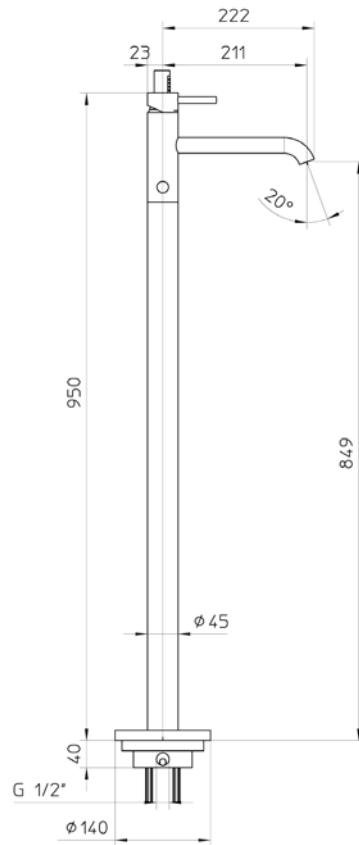

99571799



Podłogowy element montażowy.

NUMER KATALOGOWY	CENA NETTO
99571799 + 121179 10	4064,-
99571799 + 121179 39	6015,-
99571799 + 121179 79 80 81 82 83 84 85 86 87 88 89	6804,-



**ITALIAN
DESIGN**



992799 + 122335



Bidetta

Bateria podtynkowa z mieszaczem
do bidetu / WC słuchawka, wąż 1,5 m

NUMER KATALOGOWY	CENA NETTO
992799 + 122335 10	1436,-
992799 + 122335 39	2339,-
992799 + 122335 79 80 81 82 83 84 85 86 87 88 89	2569,-

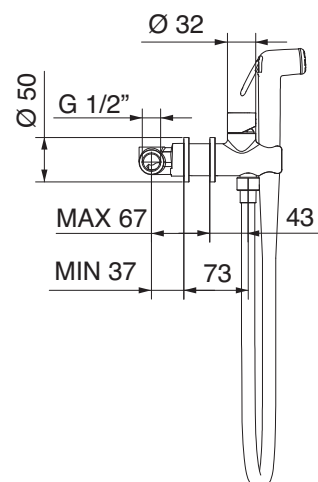

962268



Kolumna prysznicowa z termostatem, wąż 1,5 m

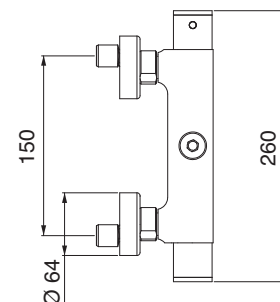
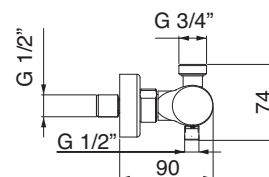
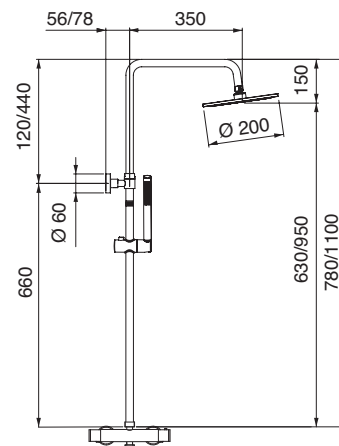

NUMER KATALOGOWY	CENA NETTO
962268 10	1999,-
962268 39	3359,-
962268 79 80 81 82 83 84 * 85 86 87 88 89	4599,-

* kolory PVD dostępne od czerwca 2024

9921R1



Wylewka wannowa 204 mm

NUMER KATALOGOWY	CENA NETTO
9921R1 10	455,-
9921R1 39	685,-
9921R1 79 80 81 82 83 84 85 86 87 88 89	823,-

991424



Korek CLICK-CLACK

NUMER KATALOGOWY	CENA NETTO
991424 10	207,-
991424 39	345,-
991424 79 80 81 82 83 84 85 86 87 88 89	409,-

PALAZZANI

MONTECARLO

MONTECARLO



**ITALIAN
DESIGN**

CHROMOWANE



10
Chrome

KOLORY MATOWE



39
graphite
matt Black

TECHNOLOGIA PVD KOLOR



79
polish
Nickel



80
brushed
Steel



81
polish
dark Nickel



82
brushed
dark Nickel



83
polish
Gold



84
brushed
Brass



85
polish
rose Gold



86
brushed
rose gold



87
polish
champagne Gold



88
brushed
champagne Gold



89
brushed
copper Bronze



- » nowoczesna technologia **PVD KOLOR**
- » powierzchnia antyalergiczna i antybakteryjna
- » grubość warstwy z kolorem minimum 20 mikronów
- » bardzo twarda powierzchnia odporna na czynniki zewnętrzne
- » brak skłonności do korozji
- » odporność na odbarwienia, uszkodzenia i ścieranie

803011

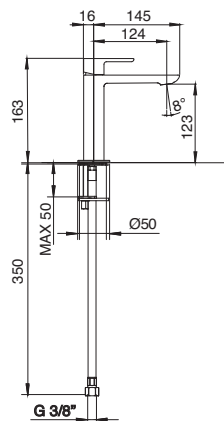

MONTECARLO
Bateria umywalkowa bez korka

NUMER KATALOGOWY	CENA NETTO
803011 10	749,-
803011 39	1179,-
803011 79 80 81 82 83 84 85 86 87 88 89	1259,-

995720 + 803272



MONTECARLO
Bateria umywalkowa podtynkowa ścienna

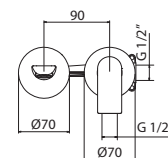
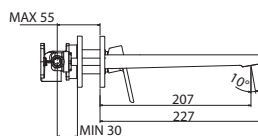

NUMER KATALOGOWY	CENA NETTO
995720 + 803272 10	1299,-
995720 + 803272 39	1749,-
995720 + 803272 79 80 81 82 83 84 85 86 87 88 89	1849,-

803018

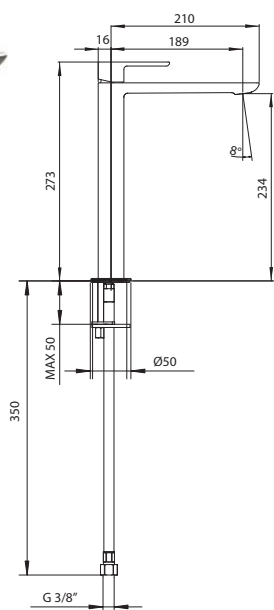

MONTECARLO
Bateria umywalkowa wysoka bez korka

NUMER KATALOGOWY	CENA NETTO
803018 10	1319,-
803018 39	1969,-
803018 79 80 81 82 83 84 85 86 87 88 89	2109,-



9921H9

MONTECARLO

Wylewka umywalkowa sufitowa

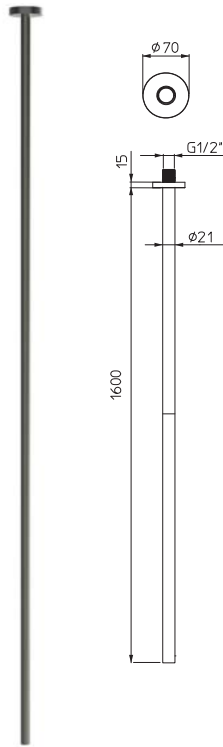

NUMER KATALOGOWY	CENA NETTO
9921H9 10	1455,-
9921H9 39	2330,-
9921H9 79 80 81 82 83 84 85 86 87 88 89	2330,-

803287

MONTECARLO

Mieszacz do wylewki sufitowej - montaż na blacie

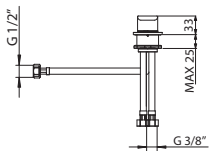

NUMER KATALOGOWY	CENA NETTO
803287 10	549,-
803287 39	849,-
803287 79 80 81 82 83 84 85 86 87 88 89	945,-

995715 + 802178

MONTECARLO

Mieszacz podtynkowy do wylewki sufitowej - montaż na ścianie

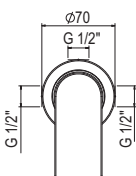
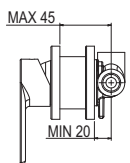

NUMER KATALOGOWY	CENA NETTO
995715 + 802178 10	712,-
995715 + 802178 39	925,-
995715 + 802178 79 80 81 82 83 84 85 86 87 88 89	1004,-

804011

MONTECARLO

Bateria bidetowa bez korka

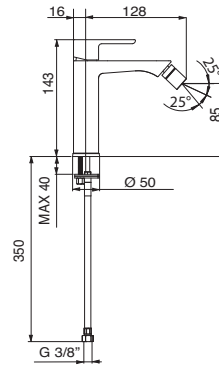

NUMER KATALOGOWY	CENA NETTO
804011 10	749,-
804011 39	1179,-
804011 79 80 81 82 83 84 85 86 87 88 89	1259,-

802015

MONTECARLO

Bateria prysznicowa

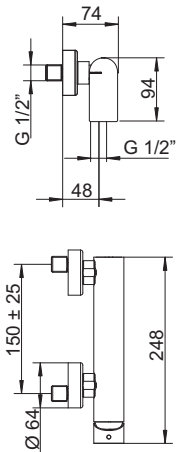

NUMER KATALOGOWY	CENA NETTO
802015 10	629,-
802015 39	1009,-
802015 79 80 81 82 83 84 85 86 87 88 89	1139,-

801216

MONTECARLO

Bateria wannowa ścienna

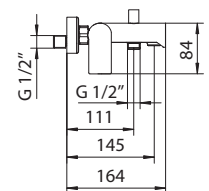

NUMER KATALOGOWY	CENA NETTO
801216 10	709,-
801216 39	1089,-
801216 79 80 81 82 83 84 85 86 87 88 89	1219,-

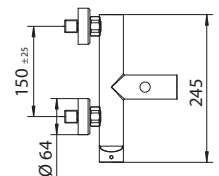

**ITALIAN
DESIGN**

MONTECARLO MONTECARLO

ZESTAW NATRYSKOWY

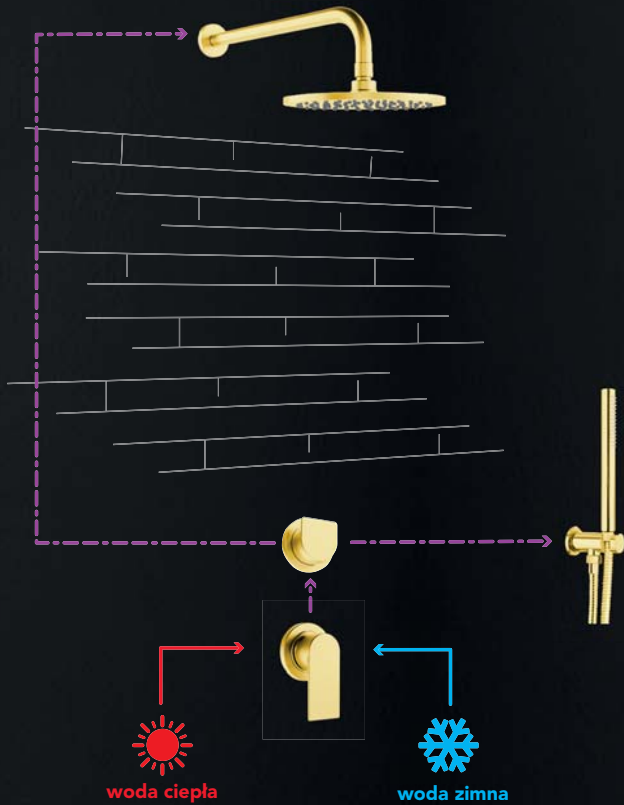

ZESTAWY NATRYSKOWE

9926V2

Ramię ścienne
długość 350 mm



9926V2

Ramię ścienne
długość 350 mm



926A7

Deszczownica okrągła Ø 300 mm **MOSIĄDZ**

926A7

Deszczownica okrągła Ø 300 mm **MOSIĄDZ**

9910U4

Zestaw:
złącze kątowe ścienne,
wąż, słuchawka **MOSIĄDZ**



9910U4

Zestaw:
złącze kątowe ścienne,
wąż, słuchawka **MOSIĄDZ**



+



802327
+ 995715

MONTECARLO
Przełącznik funkcji
+ element podtynkowy
UNICO 2-ujście 1/2"



802178
+ 995715

MONTECARLO
2 x mieszacz
+ 2 x element podtynkowy
UNICO 1-ujście 1/2"

802178
+ 995715

MONTECARLO
Mieszacz
+ element podtynkowy
UNICO 1-ujście 1/2"



OPIS	CENA NETTO
Zestaw CHROM	2893,-
Zestaw KOLOR MAT	5205,-
Zestaw KOLOR PVD	6038,-

OPIS	CENA NETTO
Zestaw CHROM	2929,-
Zestaw KOLOR MAT	5244,-
Zestaw KOLOR PVD	6079,-



MONTECARLO

MONTECARLO

ZESTAW WANNOWY



ITALIAN DESIGN

9921P2

MONTECARLO
Wylewka podtynkowa wannowa



9910U4

Zestaw:
złącze kątowe ściennie,
wąż, słuchawka MOSIĄDZ



802327
+ 995715

MONTECARLO
Przełącznik funkcji
+ element podtynkowy
UNICO 2-ujścia 1/2"



802178
+ 995715

MONTECARLO
Mieszacz
+ element podtynkowy
UNICO 1-ujście 1/2"



OPIS	CENA NETTO
Zestaw CHROM	2693,-
Zestaw KOLOR MAT	4160,-
Zestaw KOLOR PVD	4599,-

**ITALIAN
DESIGN**



MONTECARLO
MONTECARLO

801394



MONTECARLO
Bateria wannowa 4-otworowa

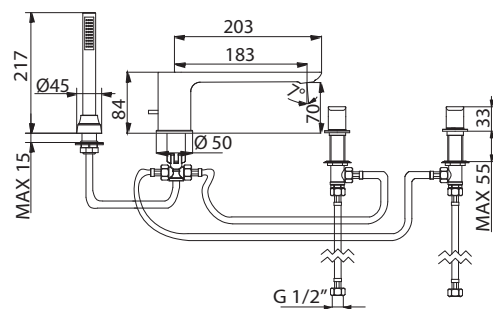

NUMER KATALOGOWY	CENA NETTO
801394 10	3150,-
801394 39	5439,-
801394 79 80 81 82 83 84 85 86 87 88 89	5629,-



801220

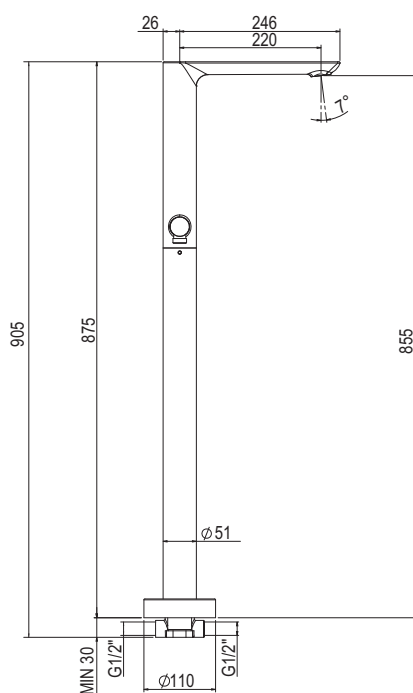

995753 + 801220*

MONTECARLO
bateria wannowa podłogowa z podłogowym elementem montażowym.

995753

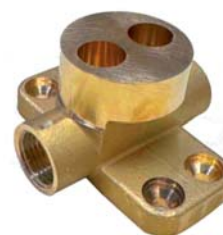

Podłogowy element montażowy.

NUMER KATALOGOWY	CENA NETTO
995753 + 801220 10	6859,-
995753 + 801220 39	9950,-
995753 + 801220 79 80 81 82 83 84 85 86 87 88 89	10399,-

**ITALIAN
DESIGN**



DRAG

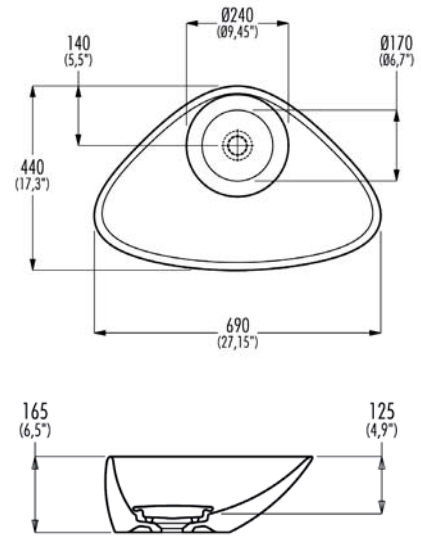

DRAG
Umywarka 690mm



NR KATALOGOWY **CENA NETTO**

C50303 1659,-

SHIFT

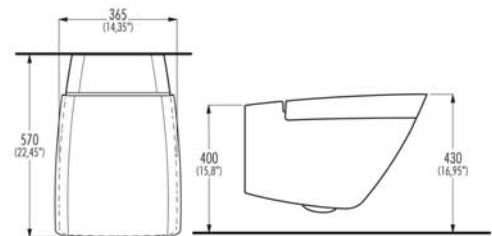

SHIFT
miska WC + deska wolnoopadająca

NR KATALOGOWY **CENA NETTO**

C65601+C65701 2029,-

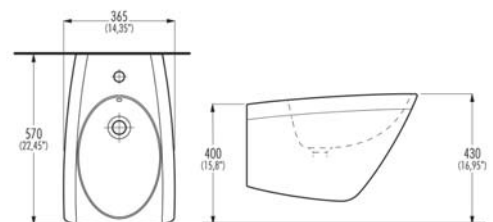

SHIFT
bidet wiszący

NR KATALOGOWY **CENA NETTO**

C65401 1585,-

UNICO
UNICO



**ITALIAN
DESIGN**

99572099



UNICO
Element podtynkowy
umywalka

CENA NETTO

342,-

99571599



UNICO
Element podtynkowy
1-ujście 1/2"

CENA NETTO

235,-

99573502



UNICO
Element podtynkowy
2 ujścia 1/2"

CENA NETTO

685,-

99279902



UNICO
Element podtynkowy do BIDETTY
1-ujście 1/2"

CENA NETTO

320,-

99571799



UNICO
Podłogowy element montażowy
baterii wannowej

CENA NETTO

934,-

99277310



UNICO
Element podtynkowy 2-ujścia 1/2"
termostat

CENA NETTO

1239,-

99575302



UNICO MONTECARLO
Podłogowy element montażowy
baterii wannowej

CENA NETTO

915,-

* ISTNIEJE MOŻLIWOŚĆ KOMPLETACJI NATYNKÓW W KOLORACH, KODY ORAZ CENY NA ELEMENTY ZEWNĘTRZNE DOSTĘPNE W KATALOGACH PALAZZANI 9.0

MAXI

 **ITALIAN**
DESIGN 





CR



NO



GR



GM

WYKOŃCZENIA

CR CHROME
NO MATT BLACK

GR GRAPHITE
GM GUN METAL

MAX0053

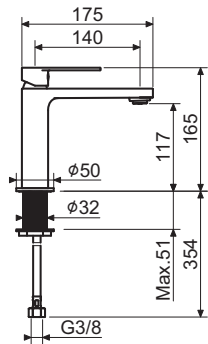

MAXI
Bateria umywalkowa
bez korka

NUMER KATALOGOWY	CENA NETTO
MAX0053 CR	535,-
MAX0053 NO	739,-
MAX0053 GR	859,-
MAX0053 GM	969,-

MAX0063

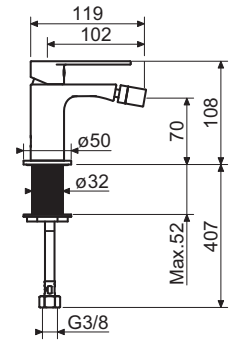

MAXI
Bateria bidetowa
bez korka

NUMER KATALOGOWY	CENA NETTO
MAX0063 CR	535,-
MAX0063 NO	739,-
MAX0063 GR	859,-
MAX0063 GM	969,-

MAX0052

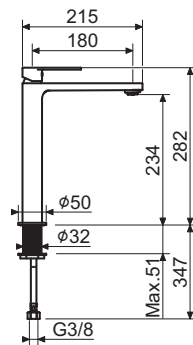

MAXI
Bateria umywalkowa
wysoka
bez korka

NUMER KATALOGOWY	CENA NETTO
MAX0052 CR	947,-
MAX0052 NO	1281,-
MAX0052 GR	1516,-
MAX0052 GM	1709,-

ORS1135 + MAX1111 + ORT0058

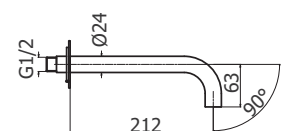
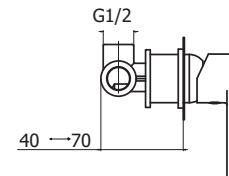

MAXI
Bateria umywalkowa
podtynkowa ścienna

NUMER KATALOGOWY	CENA NETTO
MAX1111 + ORT0058 CR	1089,-
MAX1111 + ORT0058 NO	1399,-
MAX1111 + ORT0058 GR	1589,-
MAX1111 + ORT0058 GM	1749,-

ORS5020

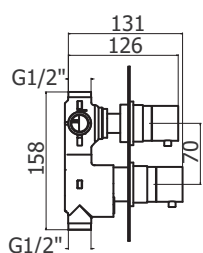
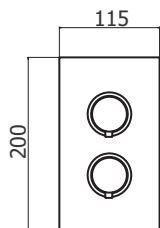

MAXI
Bateria podtynkowa
z termostatem
(2 ujścia - komplet)

NUMER KATALOGOWY	CENA NETTO
ORS5020 CR	1989,-
ORS5020 NO	2779,-
ORS5020 GR	3179,-
ORS5020 GM	3569,-

ORS1135 + MAX1111

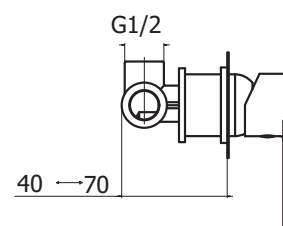

MAXI
Bateria podtynkowa
z mieszaczem
(1 ujście - komplet)

NUMER KATALOGOWY	CENA NETTO
MAX1111 CR	559,-
MAX1111 NO	679,-
MAX1111 GR	736,-
MAX1111 GM	795,-

MAX0020

MAXI
Bateria wannowa ścienna
z zestawem prysznicowym

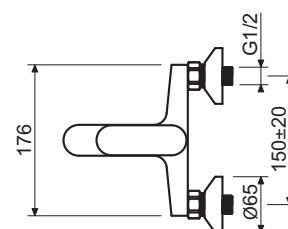
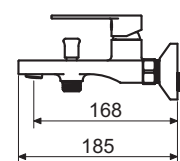

NUMER KATALOGOWY	CENA NETTO
MAX0020 CR	724,-
MAX0020 NO	919,-
MAX0020 GR	1159,-
MAX0020 GM	1303,-

MAXI

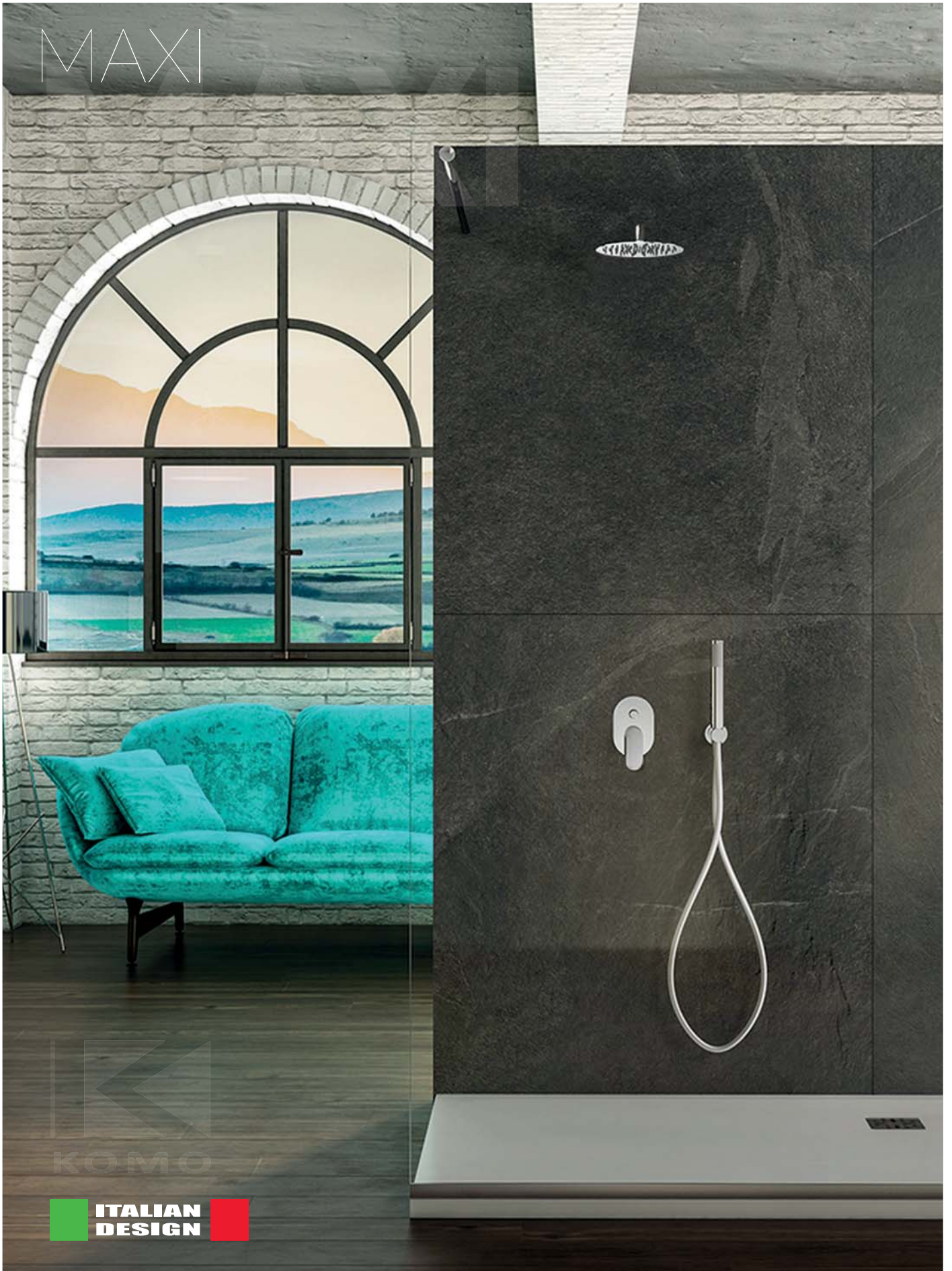

ZESTAWY NATRYSKOWE

ITP3130

Ramię ścienne
długość 400 mm



+

ITP3172

CR / NO

ITP3174

GR / GM



Deszczownica okrągła Ø 250 mm

ITP3130

Ramię ścienne
długość 400 mm



+

ITP3172

CR / NO

ITP3174

GR / GM



Deszczownica okrągła Ø 250 mm

ITP3000

Zestaw:
złącze kątowe ścienne,
wąż, słuchawka



ITP3000

Zestaw:
złącze kątowe ścienne,
wąż, słuchawka



MAX1111 (x 2) + ORS1135 (x 2)

MAXI

2 x mieszacz
+ 2 x element podtynkowy
(komplet)



+

ORS5020

MAXI / HELIOS

Bateria podtynkowa
TERMOSTAT
(komplet)



OPIS	CENA NETTO
Zestaw CR	2216,-
Zestaw NO	2802,-
Zestaw GR	3541,-
Zestaw GM	4416,-

OPIS	CENA NETTO
Zestaw CR	3087,-
Zestaw NO	4223,-
Zestaw GR	5248,-
Zestaw GM	6395,-

MAXI

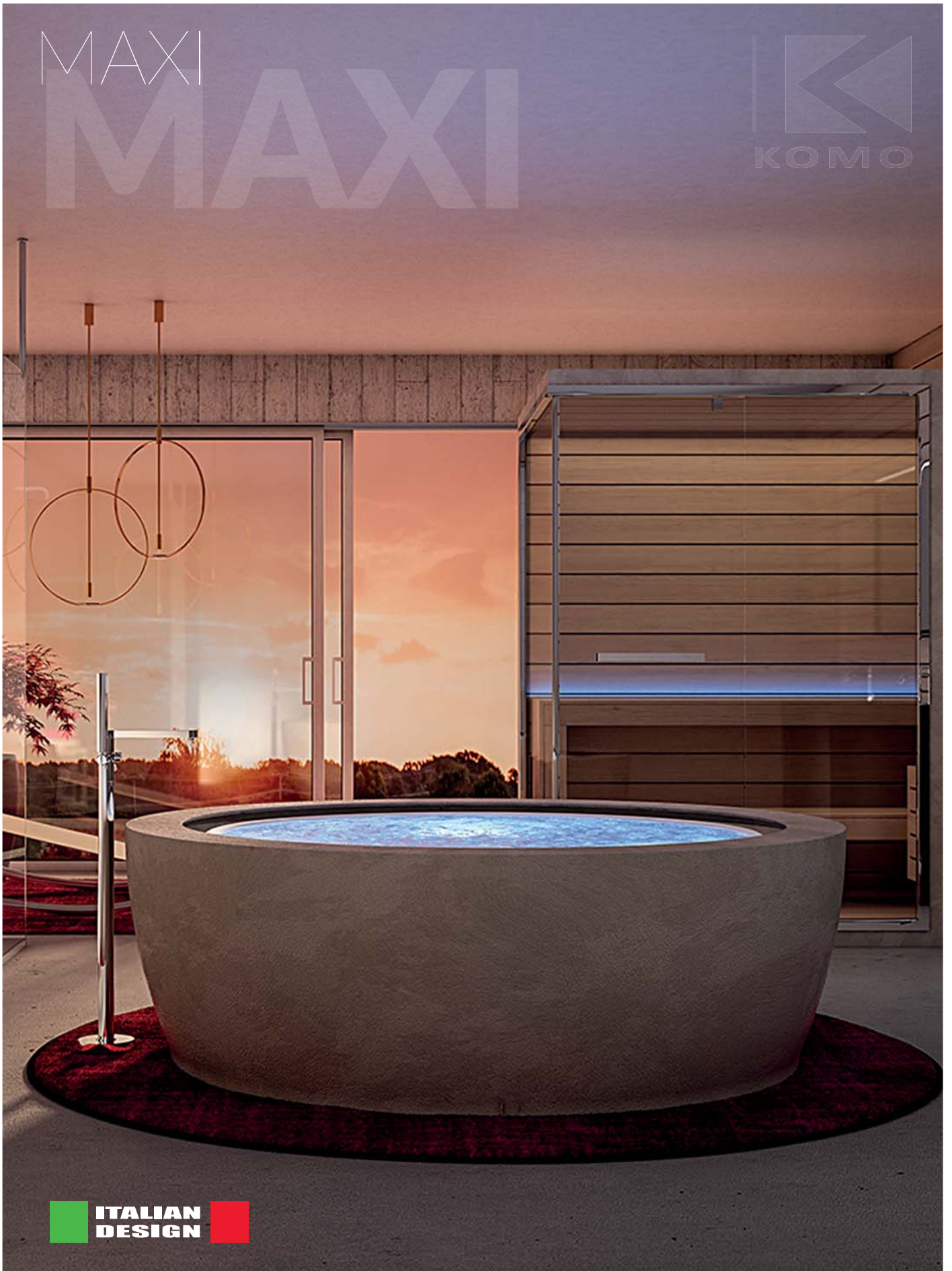

MAXI
MAXI



 **ITALIAN**
DESIGN 

MAX0091 + FIX0090

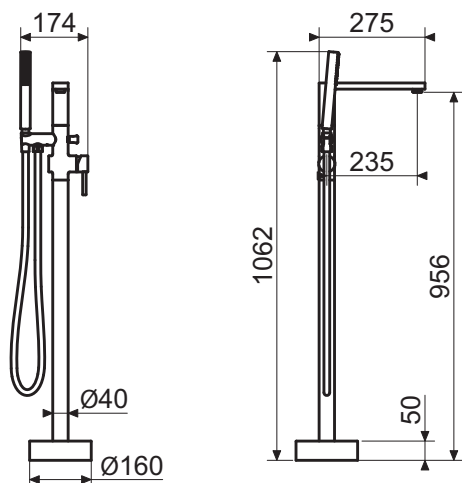
MAXI

bateria wannowa podłogowa
z podłogowym elementem montażowym,
wąż flexi.

OPIS	CENA NETTO
MAX0091 CR	4069,-
MAX0091 NO	6015,-
MAX0091 GR	6991,-
MAX0091 GM	7872,-

FIX0090



Podłogowy
element montażowy.

NUMER KATALOGOWY	CENA NETTO
FIX0090	447,-



MAX2000

MAXI

Bateria podtynkowa z mieszaczem do bidetu / WC słuchawka, wąż 1,5 m

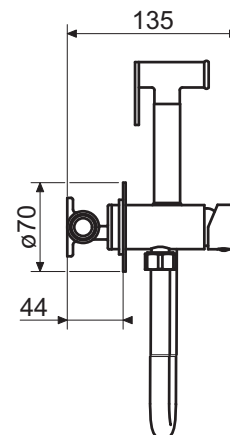
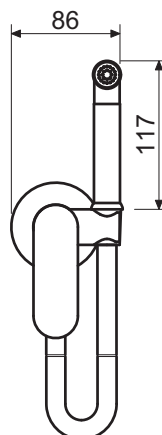

NR KATALOGOWY	CENA NETTO
MAX2000 CR	725,-
MAX2000 NO	999,-
MAX2000 GR	1159,-
MAX2000 GM	1299,-

ORT0058

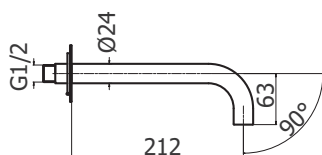

Wylewka ścienna umywalkowa / wannowa

NR KATALOGOWY	CENA NETTO
ORT0058 CR	530,-
ORT0058 NO	720,-
ORT0058 GR	853,-
ORT0058 GM	954,-

ITP4200

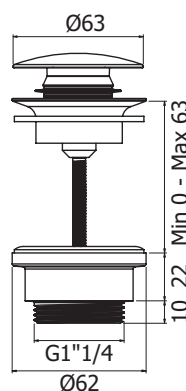

Korek CLICK-CLACK

NR KATALOGOWY	CENA NETTO
ITP4200 CR	157,-
ITP4200 NO	223,-
ITP4200 GR	252,-
ITP4200 GM	325,-

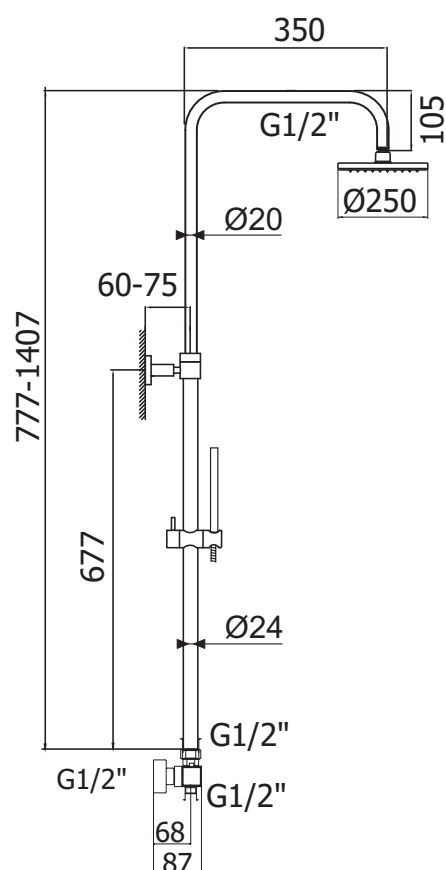

ITP6302

**MAXI WELLNESS**

Kolumna prysznicowa z termostatem,
wąż 1,5 m

OPIS	CENA NETTO
ITP6302 CR	2599,-
ITP6302 NO	3659,-
ITP6302 GM	4229,-
ITP6302 GM	4799,-

INOX + HELIOS

 **ITALIAN**
DESIGN 



INOX + HELIOS

INOX + HELIOS

WYKOŃCZENIA

IN	INOX
CR	CHROME
NO	MATT BLACK
GR	GRAPHITE
GM	GUN METAL



IN



CR



NO



GR



GM



INO0053

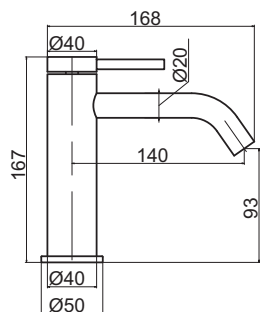

INOX
Bateria umywalkowa
bez korka

NUMER KATALOGOWY	CENA NETTO
INO0053	1349,-

INO0063

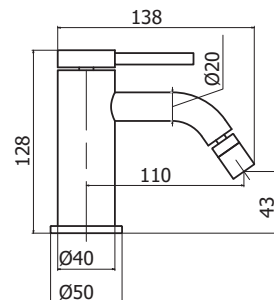

INOX
Bateria bidetowa
bez korka

NUMER KATALOGOWY	CENA NETTO
INO0063	1869,-

INO0052

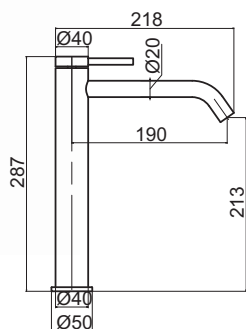

INOX
Bateria umywalkowa wysoka
bez korka

NUMER KATALOGOWY	CENA NETTO
INO0052	1349,-

ORS0037 + INO1000 + INO0058

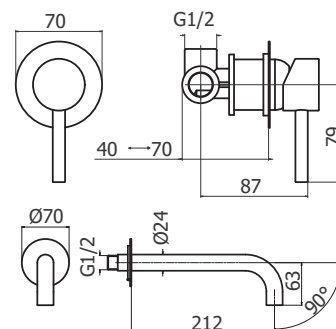

INOX
Bateria umywalkowa
podtynkowa ścienna

NUMER KATALOGOWY	CENA NETTO
INO1000 + INO0058	1849,-

ORS0037 + INO1000

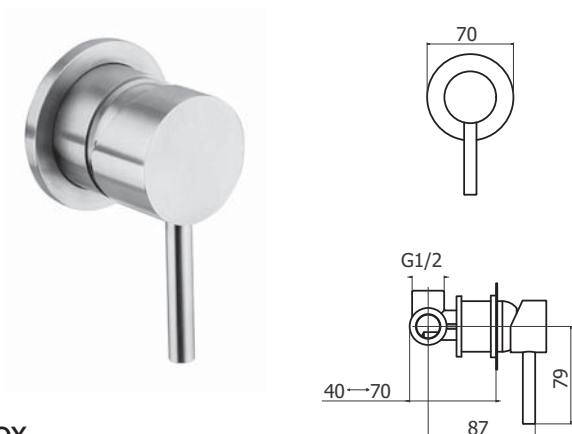

INOX
Bateria podtynkowa
z mieszaczem
(1 ujęcie - komplet)

NUMER KATALOGOWY	CENA NETTO
INO1000	1279,-

INO0091 + FIX0090

INOX
Bateria wannowa podłogowa
z podłogowym elementem montażowym

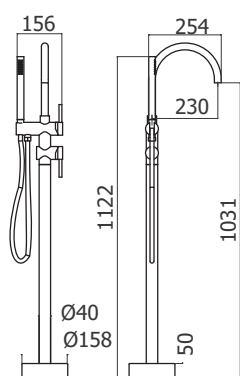

NUMER KATALOGOWY	CENA NETTO
INO0091	7169,-

FIX0090



NUMER KATALOGOWY	CENA NETTO
FIX0090	447,-

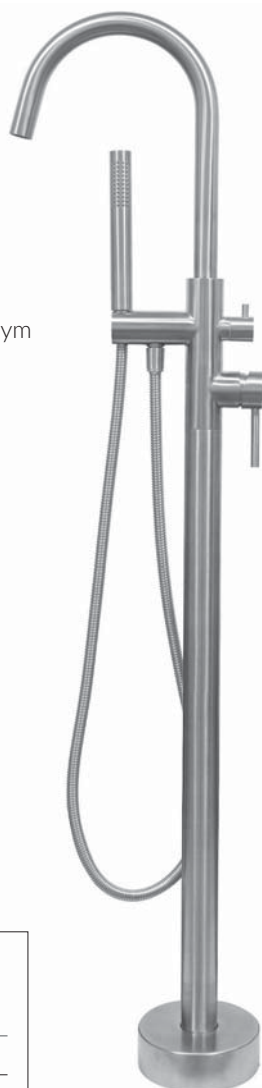

INO3130

Ramię ścienne
długość 400 mm



+

INO3173 INOX

Deszczownica okrągła Ø 360 mm



INO0300 + INO0100 + INO0402

Zestaw: złącze kątowe ścienne,
wąż, słuchawka



INO1000 (x 2) + ORS0037 (x 2)

INOX
2 x mieszacz
+ 2 x element podtynkowy
(komplet)



+

OPIS	CENA NETTO
Zestaw INOX	6051,-

HEL0053

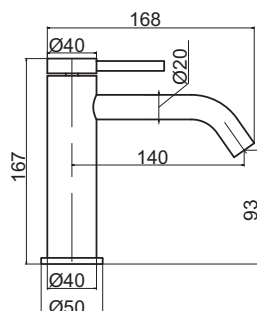

HELIOS
Bateria umywalkowa
bez korka

NUMER KATALOGOWY	CENA NETTO
HEL0053 CR	919,-
HEL0053 NO	1199,-
HEL0053 GR	1469,-
HEL0053 GM	1639,-

HEL0063

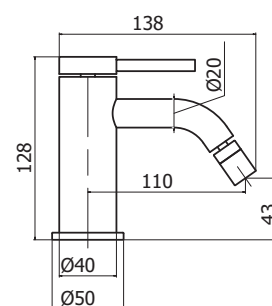

HELIOS
Bateria bidetowa
bez korka

NUMER KATALOGOWY	CENA NETTO
HEL0063 CR	919,-
HEL0063 NO	1199,-
HEL0063 GR	1469,-
HEL0063 GM	1639,-

HEL0052

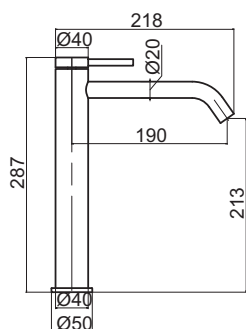

HELIOS
Bateria umywalkowa wysoka
bez korka

NUMER KATALOGOWY	CENA NETTO
HEL0052 CR	1269,-
HEL0052 NO	1749,-
HEL0052 GR	1999,-
HEL0052 GM	2299,-

HEL0020

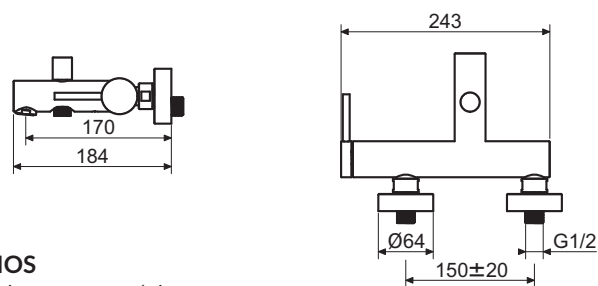

HELIOS
Bateria wannowa ścienna
z zestawem prysznicowym

NUMER KATALOGOWY	CENA NETTO
HEL0020 CR	1945,-
HEL0020 NO	2699,-
HEL0020 GR	3099,-
HEL0020 GM	3499,-

ORS1135 + HEL1111 + ORT0058

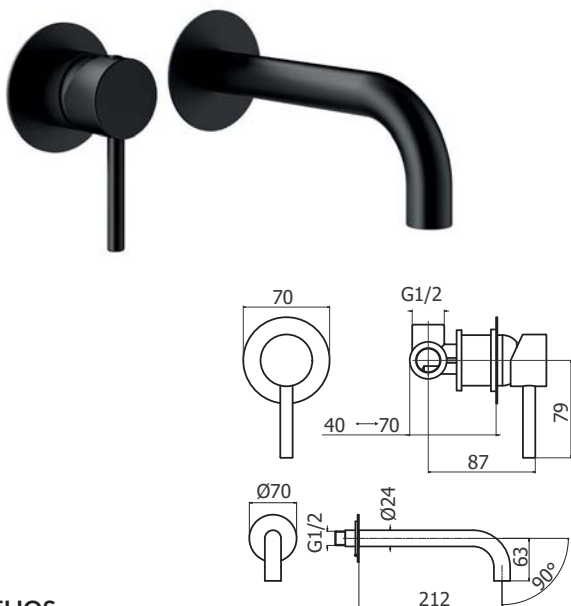

HELIOS
Bateria umywalkowa
podtynkowa ścienna

NUMER KATALOGOWY	CENA NETTO
HEL1111 + ORT0058 CR	1089,-
HEL1111 + ORT0058 NO	1399,-
HEL1111 + ORT0058 GR	1589,-
HEL1111 + ORT0058 GM	1749,-

ORS1135 + HEL1111

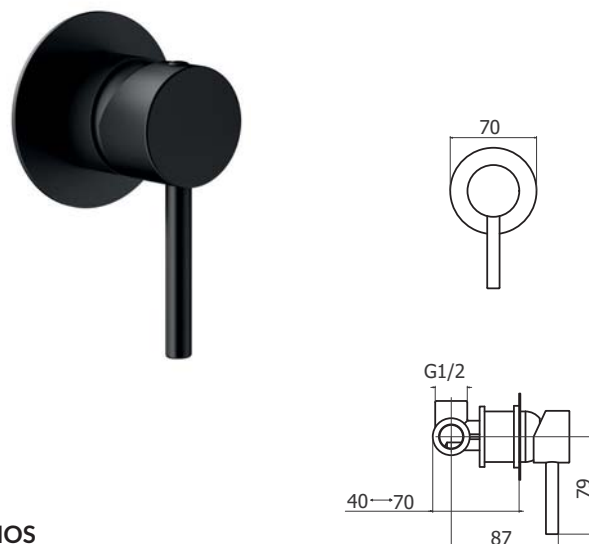

HELIOS
Bateria podtynkowa
z mieszaczem
(1 ujęcie - komplet)

NUMER KATALOGOWY	CENA NETTO
HEL1111 CR	559,-
HEL1111 NO	679,-
HEL1111 GR	736,-
HEL1111 GM	795,-

HEL0025

HELIOS
Bateria wannowa
4-otworowa

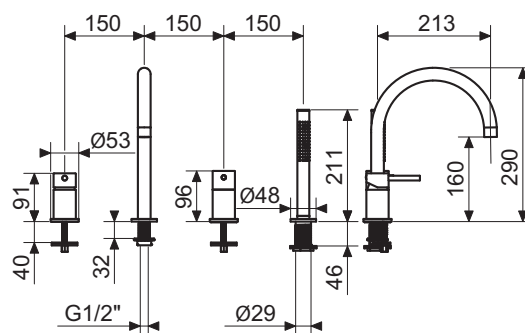

NUMER KATALOGOWY	CENA NETTO
HEL0025 CR	2930,-
HEL0025 NO	4100,-
HEL0025 GR	4400,-
HEL0025 GM	5285,-



**ITALIAN
DESIGN**

KOMO

ZESTAWY NATRYSKOWE

ITP3130

Ramię ścienne
długość 400 mm



+

ITP3172

CR / NO

ITP3174

GR / GM



Deszczownica okrągła Ø 250 mm

ITP3130

Ramię ścienne
długość 400 mm



+

ITP3172

CR / NO

ITP3174

GR / GM



Deszczownica okrągła Ø 250 mm

ITP3000

Zestaw: złącze kątowe ścienne,
wąż, słuchawka



ITP3000

Zestaw: złącze kątowe ścienne,
wąż, słuchawka



HEL1111 (x 2)
+ ORS1135 (x 2)

HELIOS

2 x mieszacz
+ 2 x element podtynkowy
(komplet)



+

ORS5020

HELIOS / MAXI

Bateria podtynkowa
TERMOSTAT
(komplet)



OPIS	CENA NETTO
Zestaw CR	2216,-
Zestaw NO	2802,-
Zestaw GR	3541,-
Zestaw GM	4416,-

OPIS	CENA NETTO
Zestaw CR	3087,-
Zestaw NO	4223,-
Zestaw GR	5248,-
Zestaw GM	6395,-



HEL0091 + FIX0090

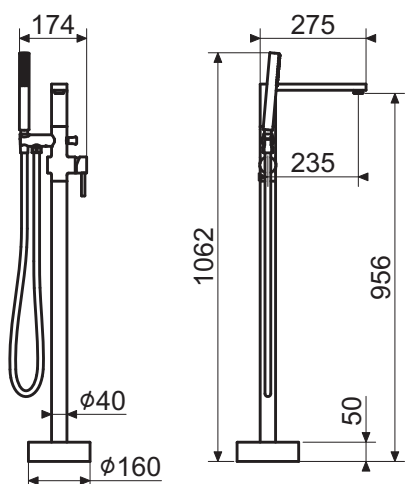

HELIOS

bateria wannowa podłogowa
z podłogowym elementem montażowym,
wąż flexi.

OPIS	CENA NETTO
HEL0091 CR	4559,-
HEL0091 NO	6295,-
HEL0091 GR	7295,-
HEL0091 GM	8199,-

FIX0090



Podłogowy
element montażowy.

NUMER KATALOGOWY	CENA NETTO
FIX0090	447,-



**ITALIAN
DESIGN**



KOMO

HEL2000

HELIOS

Bateria podtynkowa z mieszaczem do bidetu / WC słuchawka, wąż 1,5 m

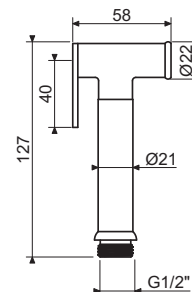
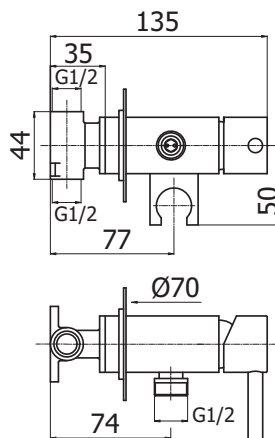

OPIS	CENA NETTO
HEL2000 CR	725,-
HEL2000 NO	999,-
HEL2000 GR	1159,-
HEL2000 GM	1299,-

ORT0058

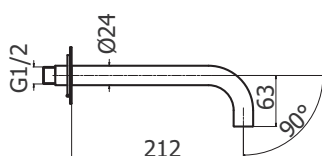

Wylewka ścienna umywalkowa / wannowa

OPIS	CENA NETTO
ORT0058 CR	530,-
ORT0058 NO	720,-
ORT0058 GR	843,-
ORT0058 GM	954,-

ITP4200

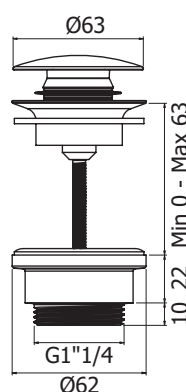

Korek CLICK-CLACK

NR KATALOGOWY	CENA NETTO
ITP4200 CR	157,-
ITP4200 NO	223,-
ITP4200 GR	252,-
ITP4200 GM	325,-

STELAŻE PODTYNKOWE

JOMOTech
komplet 3 w 1



NR KATALOGOWY
103-000000079

**Stelaż podtynkowy
ze wspornikami**

+ Przycisk SWITCH
BIAŁY

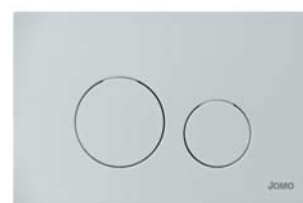

CENA NETTO

844,-

NR KATALOGOWY
103-000000081

**Stelaż podtynkowy
ze wspornikami**

+ Przycisk SWITCH
CHROM



CENA NETTO

966,-

NR KATALOGOWY
103-000000080

**Stelaż podtynkowy
ze wspornikami**

+ Przycisk SWITCH
CZARNY MATOWY



CENA NETTO

966,-

PAKIET JOMOTech

NR KATALOGOWY

103-000000005

**Stelaż podtynkowy
+ wspornik**



1120 mm

CENA NETTO

779,-

DO KOMPLETACJI Z PRZYCISKAMI SWITCH!

NR KATALOGOWY

102-000000440

Przycisk SWITCH
CZARNY MATOWY
/ MIEDŹ



CENA NETTO

269,-

lub

NR KATALOGOWY

102-000000442

Przycisk SWITCH
CZARNY MATOWY
/ ŻŁOTY MATOWY



CENA NETTO

269,-

lub

NR KATALOGOWY

102-000000441

Przycisk SWITCH
MIEDŹ
/ CZARNY MATOWY



CENA NETTO

285,-

lub

NR KATALOGOWY

102-000000443

Przycisk SWITCH
ŻŁOTY MATOWY
/ CZARNY MATOWY



CENA NETTO

285,-



NOWOŚĆ

STELAŻE PODTYNKOWE

JOMOTech komplet 4 w 1



NR KATALOGOWY

103-000000010
+ 116-000000380

- stelaż podtynkowy
- wsporniki
- przycisk EXCLUSIVE 2.0 chrom połysk
- uszczelka akustyczna

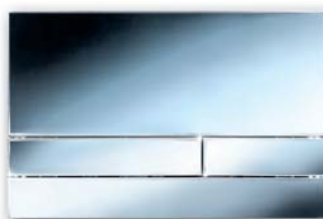

CENA NETTO

975,-

JOMOTech komplet 4 w 1



NR KATALOGOWY

103-000000015
+ 116-000000380

- stelaż podtynkowy
- wspornik
- przycisk EXCLUSIVE 2.0 czarny matowy z ABS
- uszczelka akustyczna



CENA NETTO

975,-

JOMOTech komplet 4 w 1



NR KATALOGOWY

103-000000008
+ 116-000000380

- stelaż podtynkowy
- wsporniki
- przycisk EXCLUSIVE 2.0 biały
- uszczelka akustyczna

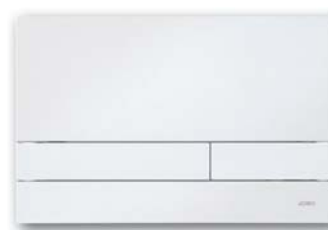

CENA NETTO

853,-

JOMOTech STELAŻ BIDETOWY

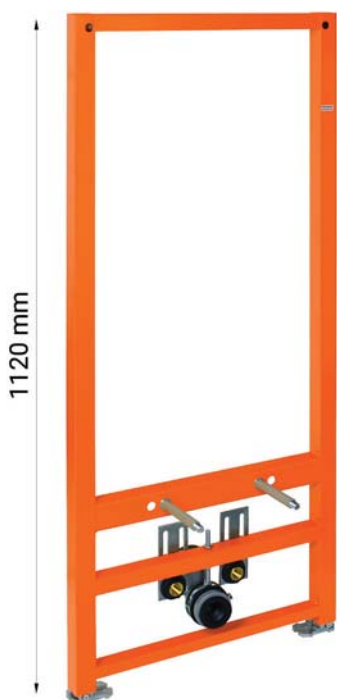

nr katalogowy

105-000000001
+ 116-000000342

- stelaż podtynkowy bidetowy
- wsporniki

CENA NETTO

569,-



175-30650400-38

Odptyw liniowy 650 mm / maskownica do wypełnienia FLIS / mata uszczelniająca wykończenie BLACK MAT

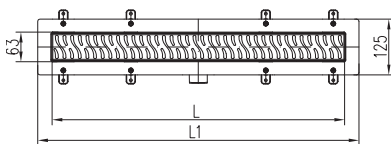
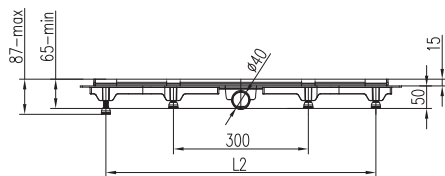

CENA NETTO

539,-

175-30650400-00

Odptyw liniowy 650 mm / maskownica do wypełnienia FLIS / mata uszczelniająca

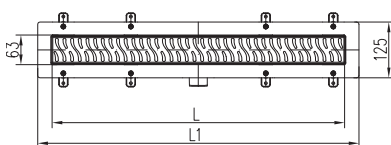
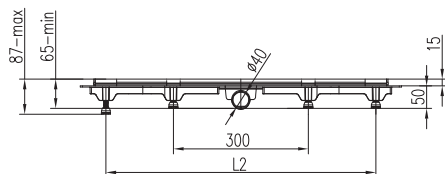

CENA NETTO

539,-

175-30750400-38

Odptyw liniowy 750 mm / maskownica do wypełnienia FLIS / mata uszczelniająca wykończenie BLACK MAT

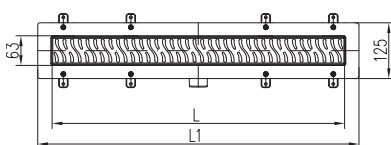
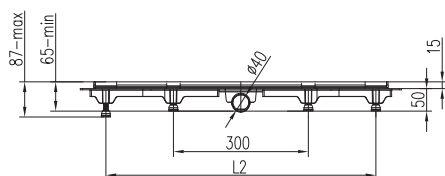

CENA NETTO

539,-

175-30750400-00

Odptyw liniowy 750 mm / maskownica do wypełnienia FLIS / mata uszczelniająca

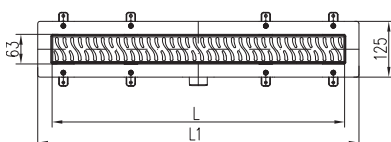
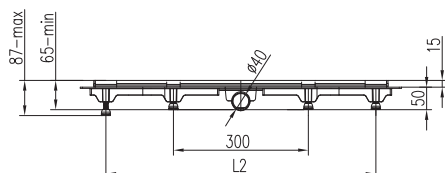

CENA NETTO

539,-

31.017.00



Design chrom
Pósyfon umywalkowy

CENA NETTO

149,-

31.020.56



Pósyfon umywalkowy
wykończenie BLACK MAT

CENA NETTO

219,-

34.057.81



Syfon brodzikowy Ø 90 mm
głębokość 6 cm

CENA NETTO

159,-

34.051.56



Syfon brodzikowy Ø 90 mm
głębokość 8 cm
wykończenie BLACK MAT

CENA NETTO

99,- *

35.327.56

Syfon wannowy
automatyczny
z napełnianiem
przez przelew
wykończenie
BLACK MAT



CENA NETTO

739,-

35.327.00

Syfon wannowy
automatyczny
z napełnianiem
przez przelew



CENA NETTO

699,-

35.333.56

Syfon wannowy
automatyczny
wykończenie
BLACK MAT



CENA NETTO

229,-

* do wyczerpania zapasów

OFERTA INWESTYCYJNA



WALK IN ECO

POWŁOKA
OCHRONNA
SZKŁA



ECO

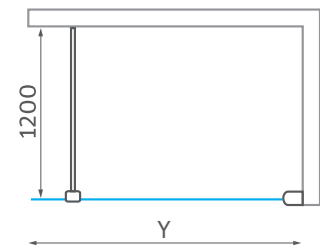
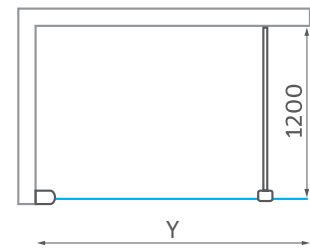

- » uniwersalna wersja lewa i prawa
- » kolor profilu BRILLANT
- » 6 mm ESG szkło bezpieczne
- » wysokość 2000 mm łącznie z elementami nośnymi
- » Y – wymiar montażowy na brodzik
- » GWARANCJA 2 LATA



Profil
BRILLANT



6 mm ESG
szkło bezpieczne
transparent

Ścianka WALK IN ECO

MODEL	NR KATALOGOWY	SZEROKOŚĆ (Y)	CENA NETTO
WALK IN ECO 800	4000678	770-790	849,-
WALK IN ECO 900	4000679	870-890	899,-
WALK IN ECO 1000	4000680	970-990	949,-
WALK IN ECO 1200	4000681	1170-1190	1059,-
WALK IN ECO 1400	4000682	1370-1390	1159,-

Roth





ALBIS



- » 5 mm ESG szkło bezpieczne
- » rodzaj szkła: transparent
- » wysokość 1900 mm
- » podwójne rolki z funkcją wypinania
- » chromowany uchwyt
- » Y – wymiar montażowy na brodzik
- » GWARANCJA 3 LATA

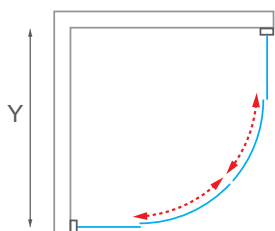

Profil
BRILLANT



5 mm ESG
szkło bezpieczne
transparent

Półokrągła kabina prysznicowa z podwójnymi drzwiami przesuwными

MODEL	NR KATALOGOWY	ROZMIAR	WYSOKOŚĆ	WEJŚCIE	CENA NETTO
ALBIS 800	N0776	770-790	1900	400	1299,-
ALBIS 900	N0777	870-890	1900	524	1399,-



SUNDIS



- » 5 mm ESG szkło bezpieczne
- » rodzaj szkła: transparent
- » wysokość 1900 mm
- » podwójne rolki z funkcją wypinania
- » chromowany uchwyt
- » Y – wymiar montażowy na brodzik
- » GWARANCJA 3 LATA

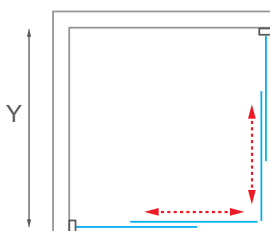

Profil
BRILLANT



5 mm ESG
szkło bezpieczne
transparent

Kwadratowa kabina prysznicowa z podwójnymi drzwiami przesuwными

MODEL	NR KATALOGOWY	ROZMIAR	WYSOKOŚĆ	WEJŚCIE	CENA NETTO
SUNDIS 800	N0778	770-790	1900	423	1319,-
SUNDIS 900	N0779	870-890	1900	494	1419,-

PALAZZANI



10
Chrome



**ITALIAN
DESIGN**

68303810

QI
Bateria umywalkowa
z korkiem automatycznym

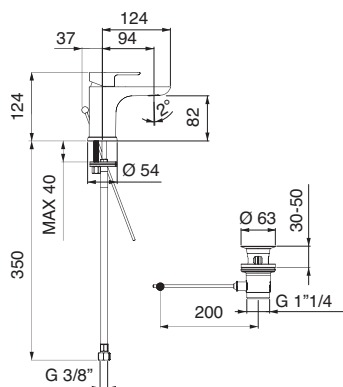

CENA NETTO

399,-

68307710

QI
Bateria umywalkowa wysoka
z korkiem CLICK-CLACK

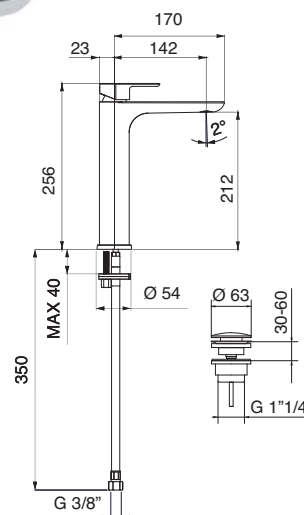

CENA NETTO

799,-

68101510

QI
Bateria wannowa
ścienna

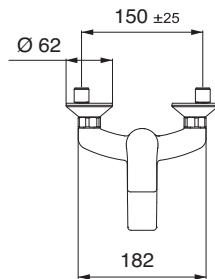
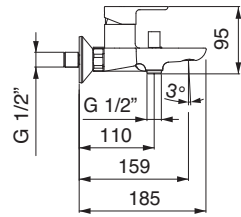

CENA NETTO

509,-

9920T210

QI
Zestaw natryskowy
słuchawka 3-strumieniowa

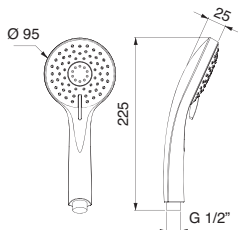

CENA NETTO

185,-

68201510

QI
Bateria prysznicowa
ścienna

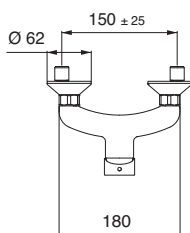

CENA NETTO

399,-

68120910 + 99587310

Ramię ścienne,
długość 250 mm



+

Deszczownica
okrągła Ø 220 mm
ABS



+



+

Zestaw:
złącze kątowe ścienne, wąż,
słuchawka Ø 95 mm ABS

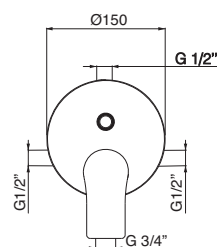
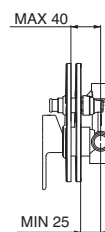

QI
Bateria podtynkowa
z mieszaczem
(2 ujścia - komplet)

OPIS

CENA NETTO

Zestaw natryskowy

999,-

NOWOŚĆ

SEVEN RIMLESS

Miska wisząca + deska wolnoopadająca
+ mocowanie
SEVEN RIMLESS

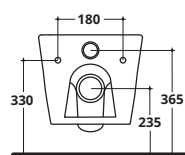
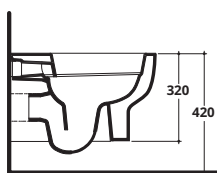
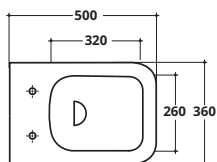

CERAMICA
ALTHEA

NR KATALOGOWY

CENA NETTO

SE013 + SE007S + 40951

819,-

JAZZ



Sanitana

Umywalka
JAZZ 62



NR KATALOGOWY

CENA NETTO

KPLV3E.10CO

235,-

AVANTGARDE



Przycisk
**AVANTGARDE
CH/CH 2.0**

**SKÓRA
CZERWONY**

JOMOTech

NR KATALOGOWY

CENA NETTO

167-30003002-00

375,- *



Przycisk
**AVANTGARDE
CH/CH 2.0**

**SKÓRA
CZARNY / MAT**

JOMOTech

NR KATALOGOWY

CENA NETTO

167-30003003-00

380,- *

BE YOU



Sanitana

Umywalka **BE YOU**
(600/430/165)

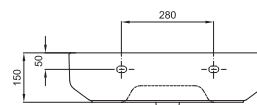
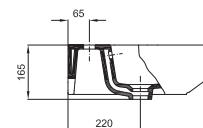
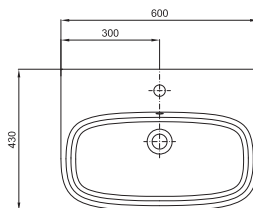

NR KATALOGOWY

CENA NETTO

S10200417200000

365,-

* do wyczerpania zapasów

CASUAL 60



Sanitana

Umywalka
CASUAL 60



NR KATALOGOWY CENA NETTO

CSLV2E.10C0 449,-

CASUAL 80



Sanitana

Umywalka
CASUAL 80



NR KATALOGOWY CENA NETTO

CSLV4E.10C0 539,-

UP RECTANGULAR



Umywalka
UP RECTANGULAR 59

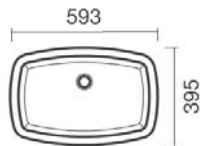

Sanitana



NR KATALOGOWY CENA NETTO

S10084550400000 369,-

UP OVAL



Umywalka
UP OVAL 59

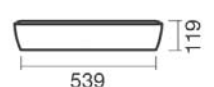
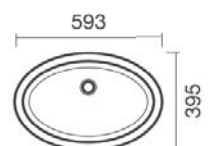

Sanitana



NR KATALOGOWY CENA NETTO

S10084350400000 369,-

OFERTA INWESTYCYJNA

POP



Umywalka
POP PRAWA
58,5 X 45

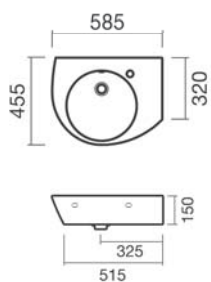

Sanitana



NR KATALOGOWY	CENA NETTO
S10014036600000	249,-

POP



Umywalka
POP LEWA
58,5 X 45

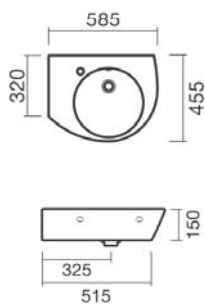

Sanitana



NR KATALOGOWY	CENA NETTO
S10084550400000	249,-

PETIT

Szafka
PRAWA ORZECH .84N
(BEZ UMYWALKI)

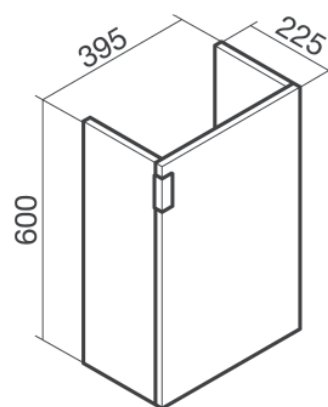
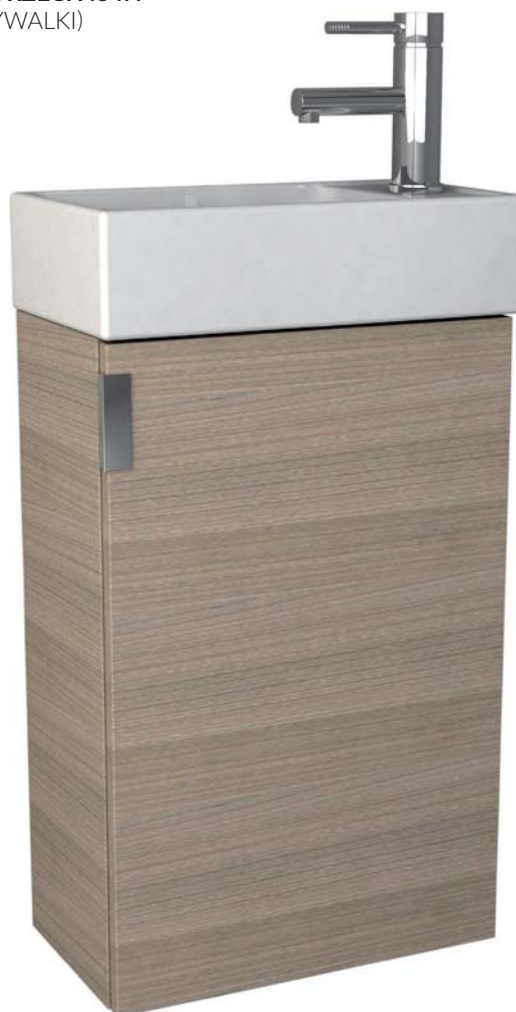

Sanitana



NR KATALOGOWY	CENA NETTO
SP0021102103500	249,-



MERLITA



WC MERLITA

Miska wisząca RIMLESS
+ deska wolnoopadająca SLIM + mocowanie.
Długość miski 49 cm

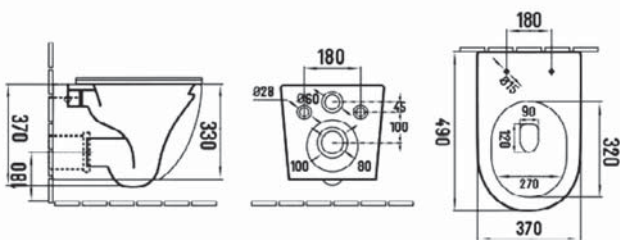

NR KATALOGOWY

CENA NETTO

CS-W02

699,-

ODPŁYW LINIOWY

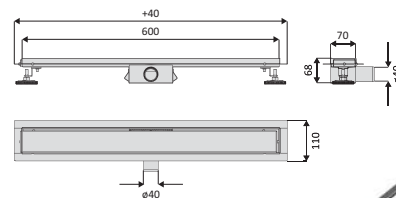

Odpływ liniowy 2w1
z wysokogatunkowej
stali nierdzewnej klasy 304,
ruszt odwracalny,
długość 60 cm.

NR KATALOGOWY

CENA NETTO

W990.ODW.600

349,-



Generalny dystrybutor:

Roth, Palazzani, Megius, Azzurra, Althea

TOP-DESIGN

ul. Białostocka 7e, 93-355 Łódź

tel. +48 42 244 94 92



Oferta ma charakter informacyjny i nie stanowi oferty w rozumieniu art. 66 § 1 kodeksu cywilnego oraz innych właściwych przepisów prawnych. Zdjęcia mają charakter poglądowy, stąd rzeczywisty wygląd produktów może różnić się od prezentowanych na zdjęciach.



biuro@topdesignsc.eu | **www.topdesignsc.eu**

www.roth-czech.cz/en | www.palazzani.eu

www.megius.com | www.azzurrabagni.com | www.altheaceramica.it